

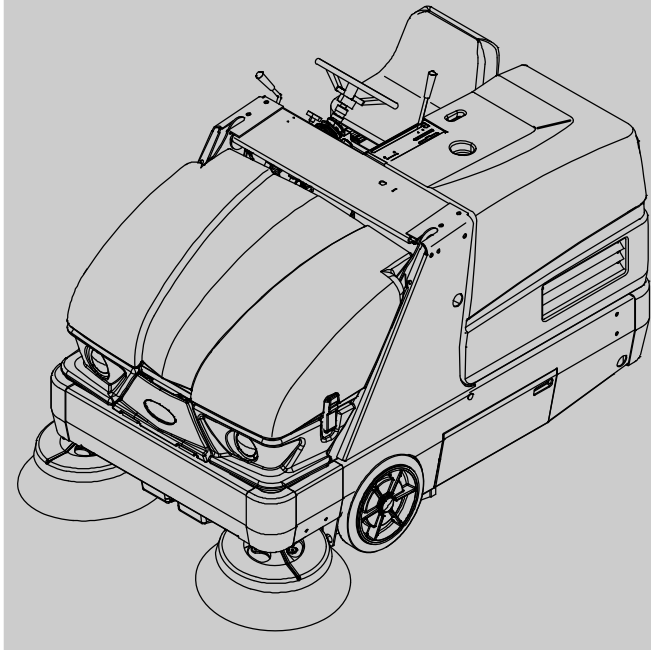

S20

(Diesel)



Sweeper Operator Manual

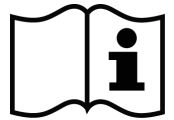

SweepMax™ System
ShakeMax™ 360
TennantTrue® Parts
IRIS® a Tennant Technology

North America / International



For the latest Parts manuals and other
language Operator manuals, visit:

www.tennantco.com/manuals

9006712
Rev. 12 (08-2019)



INTRODUCTION

This manual is furnished with each new model. It provides necessary operation and maintenance instructions.



Read this manual completely and understand the machine before operating or servicing it.

This machine will provide excellent service. However, the best results will be obtained at minimum costs if:

- The machine is operated with reasonable care.
- The machine is maintained regularly - per the machine maintenance instructions provided.
- The machine is maintained with manufacturer supplied or equivalent parts.

PROTECT THE ENVIRONMENT



Please dispose of packaging materials, used components such as batteries and fluids in an environmentally safe way according to local waste disposal regulations.



Always remember to recycle.

MACHINE DATA

Please fill out at time of installation for future reference.

Model No. - _____

Serial No. - _____

Installation Date - _____

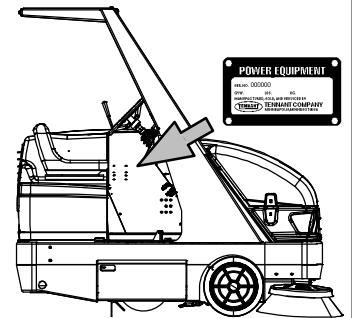

INTENDED USE

The S20 is an industrial rider machine designed to sweep hard surfaces (concrete, asphalt, stone, synthetic, etc). Typical applications include industrial warehouses, manufacturing facilities, distribution facilities, stadiums, arenas, convention centers, parking facilities, transportation terminals, and construction sites. Do not use this machine on soil, grass, artificial turf, or carpeted surfaces. This machine can be used both indoors and outdoors, but ensure there is adequate ventilation if used indoors. This machine is not intended for use on public roadways. Do not use this machine other than described in this Operator Manual.

Tennant Company

PO Box 1452

Minneapolis, MN 55440

Phone: (800) 553-8033

www.tennantco.com



CALIFORNIA PROPOSITION 65 WARNING:

Engine exhaust from this product contains chemicals known to the State of California to cause cancer, birth defects, or other reproductive harm.

Thermo-Sentry, Perma-Filter, InstantAccess, Lower total Cost of Ownership, and Duramer are trademarks of Tennant Company.

Specifications and parts are subject to change without notice.

Original Instructions, Copyright © 2009 – 2012, 2014 – 2019 TENNANT Company, Printed in U.S.A.

CONTENTS

	Page		Page
Important Safety Instructions – Save These Instructions	4	Hydraulics	41
Operation	8	Hydraulic Fluid Reservoir	41
Machine Components	8	Hydraulic Fluid	42
Controls And Instruments	9	Hydraulic Hoses	42
Symbol Definitions	10	Engine	43
Operation Of Controls	12	Cooling System	43
Directional Pedal	12	Clean The Engine And Engine Compartment	43
Brake Pedal	12	Air Filter Indicator	44
Parking Brake Pedal	12	Air Filter	44
Parking Brake Light	12	Engine Belt	45
Main Cover Lever	13	Valve Clearance	45
Steering Wheel Tilt Handle	13	Fuel Filter	45
Main Brush Adjustment Knob	13	Fuel Lines	46
Side Brush Adjustment Knob	13	Priming The Fuel System	46
Charging System Light	14	Vacuum Fan Belt	46
Engine Water Temperature Light	14	Battery	46
Clogged Dust Filter Light	14	Fuses And Relays	47
Hopper Temperature Light – Thermo–Sentry	14	Relay Panel Fuses And Relays	47
Glow Plug Light	15	Hepa (High Efficiency Particulate Arrestance) Filtration System (Option)	48
Engine Oil Pressure Light	15	Hopper	48
Hopper Door Closed Light	15	Hopper Dust Filter	49
Clogged Hydraulic Filter Light	15	Replacing The Hopper Dust Filter	49
Fuel Level Gauge	16	Check Dust Filter Seal Height	50
Hour Meter	16	Cleaning The Dust Filter	51
Operating / Hazard Lights Switch	16	Machines With Standard Filtration System	51
Operator Seat	17	Machines Equipped With Hepa Filtration System	51
Deluxe Suspension Seat (Option)	17	Cleaning The Cyclone Assembly	52
Seat Belts (Option)	17	Cleaning The Upper Cyclone Chamber	52
How The Machine Works	18	Cleaning The Lower Cyclone Chamber	53
Brush Information	18	Cleaning The Lower Cyclone Chamber (Hepa Option)	53
While Operating The Machine	19	Cyclone Perma–Filter	56
Pre–Operation Checklist	20	Inspect And Clean The Hepa Filter Housing (Option)	57
Starting The Machine	21	Main Brush	59
Turning Off The Machine	22	Replacing Or Rotating The Main Brush	59
Sweeping	23	Checking The Main Brush Pattern	60
Stop Sweeping	24	Adjusting The Main Brush Taper	60
Emptying The Hopper	25	Adjusting The Main Brush Width	61
Engaging Hopper Support Bar	27	Side Brush(Es)	61
Disengaging Hopper Support Bar	28	Replacing The Side Brush	61
Options	30	Adjusting The Side Brush Pattern	62
Vacuum Wand	30	Side Brush Guard	62
Tower Bumpers (Option)	31	Side Brush Pivot	62
Wet Side Brush Dust Control (Option)	32	Skirts, Flaps, And Seals	63
Machine Troubleshooting	33	Hopper Lip Skirt	63
Hepa Filter System Troubleshooting Table	34	Hopper Side Skirt	63
Maintenance	35	Brush Door Skirts	63
Maintenance Chart	36	Rear Skirts	63
Lubrication	40	Side Brush Dust Control Skirts (Option)	64
Engine Oil	40	Brush Door Seals	64
Rear Wheel Support	40		
Front Wheel Bearings	40		
Hopper Lift Arm Pivots	40		

CONTENTS

	Page
Hopper Seals	64
Hopper Access Door Seal	64
Inner Hopper Access Door Seal (Option – Vacuum Wand Only)	65
Hopper Door Seals	65
Filter Chamber Inlet Seal	65
Cyclonic Chamber And Dust Tray Flaps	65
Cyclone Cover Seals	66
Cyclone Cover Access Port Seal (S/N 006266 –)	66
Hopper Dust Filter Cover Seal	66
Brakes And Tires	67
Brakes	67
Tires	67
Rear Wheel	67
Propelling Motor	67
Wet Side Brush Dust Control (Option)	68
Filter Screens	68
Spray Nozzles	68
Storing The Water Tank	68
Pushing, Towing, And Transporting	
The Machine	70
Pushing Or Towing The Machine	70
Transporting The Machine	70
Machine Jacking	72
Storage Information	72
Freeze Protection For Wet Side Brush Dust Control System	72
Specifications	73
General Machine Dimensions/Capacities ..	73
General Machine Performance	74
Power Type	74
Steering	74
Hydraulic System	74
Braking System	75
Tires	75
Machine Dimensions	75

SAFETY PRECAUTIONS

IMPORTANT SAFETY INSTRUCTIONS – SAVE THESE INSTRUCTIONS

The following precautions are used throughout this manual as indicated in their description:

 **WARNING: To warn of hazards or unsafe practices that could result in severe personal injury or death.**

FOR SAFETY: To identify actions that must be followed for safe operation of equipment.

The following information signals potentially dangerous conditions to the operator. Know when these conditions can exist. Locate all safety devices on the machine. Report machine damage or faulty operation immediately.

 **WARNING: Moving belt and fan. Keep away.**

 **WARNING: Engine emits toxic gases. Serious injury or death can result. Provide adequate ventilation.**

 **WARNING: Raised hopper may fall. Engage hopper support bar.**

 **WARNING: Lift arm pinch point. Stay clear of hopper lift arms.**

 **WARNING: Burn hazard. Hot surface. Do NOT touch.**

 **WARNING: Machine can emit excessive noise. Hearing loss can result. Wear hearing protection. (Cab option only).**

 **WARNING: Accident may occur. Do not operate vacuum wand while driving. (Vacuum wand option only).**

This machine may be equipped with technology that automatically communicates over the cellular network. If this machine will be operated where cell phone use is restricted because of concerns related to equipment interference, please contact a Tennant representative for information on how to disable the cellular communication functionality.

FOR SAFETY:

1. **Do not operate machine:**
 - Unless trained and authorized.
 - Unless operator manual is read and understood.
 - Under the influence of alcohol or drugs.
 - While using a cell phone or other types of electronic devices.
 - Unless mentally and physically capable of following machine instructions.
 - If it is not in proper operating condition.
 - Without filters in place.
 - In areas where flammable vapors/liquids or combustible dusts are present.
 - In areas that are too dark to safely see the controls or operate the machine unless operating / headlights are turned on.
 - In areas with possible falling objects unless equipped with overhead guard.
2. **Before starting machine:**
 - Check machine for fluid leaks
 - Keep sparks and open flame away from refueling area.
 - Make sure all safety devices are in place and operate properly.
 - Check brakes and steering for proper operation.
 - Adjust seat and fasten seat belt. (if equipped).
3. **When starting machine:**
 - Keep foot on brake and directional pedal in neutral.
4. **When using machine:**
 - Use only as described in this manual.
 - Do not pick up burning or smoking debris, such as cigarettes, matches or hot ashes.
 - Use brakes to stop machine.
 - Go slowly on inclines and slippery surfaces.
 - Do not sweep on ramp inclines that exceed 14% grade or transport (GVWR) on ramp inclines that exceed 17.6% grade.
 - Reduce speed when turning.
 - Keep all parts of body inside operator station while machine is moving.

- Use care when reversing machine.
 - Move machine with care when hopper is raised.
 - Make sure adequate clearance is available before raising hopper.
 - Do not raise hopper when machine is on an incline.
 - Keep children and unauthorized persons away from machine.
 - Do not carry passengers on any part of the machine.
 - Always follow safety and traffic rules.
 - Report machine damage or faulty operation immediately.
5. Before leaving or servicing machine:
- Do not park near combustible materials, dust, gases, or liquids.
 - Stop on level surface.
 - Set parking brake.
 - Turn off machine and remove key.
6. When servicing machine:
- All work must be done with sufficient lighting and visibility.
 - Keep work area well ventilated.
 - Avoid moving parts. Do not wear loose clothing, jewelry and secure long hair.
 - Block machine tires before jacking machine up.
 - Jack machine up at designated locations only. Support machine with jack stands.
 - Use hoist or jack that will support the weight of the machine.
 - Do not push or tow the machine without an operator in the seat controlling the machine.
 - Do not power spray or hose off machine near electrical components.
 - Disconnect battery connections before working on machine.
 - Avoid contact with battery acid.
 - Avoid contact with hot engine coolant.
 - Do not remove cap from radiator when engine is hot.
 - Allow engine to cool.
 - Keep flames and sparks away from fuel system service area. Keep area well ventilated.
 - Use cardboard to locate leaking hydraulic fluid under pressure.
 - All repairs must be performed by trained personnel.
- Do not modify the machine from its original design.
 - Use Tennant supplied or approved replacement parts.
 - Wear personal protective equipment as needed and where recommended in this manual.
- 

For Safety: wear hearing protection.
- 

For Safety: wear protective gloves.
- 

For Safety: wear eye protection.
- 

For Safety: wear protective dust mask.
7. When loading/unloading machine onto/off truck or trailer:
- Empty debris hopper before loading machine.
 - Turn off machine and remove key.
 - Use ramp, truck or trailer that will support the weight of the machine and operator.
 - Do not load/unload on ramp inclines that exceed 25% grade.
 - Use winch. Do not drive the machine onto/off the truck or trailer unless the load height is 380 mm (15 in) or less from the ground.
 - Set parking brake after machine is loaded.
 - Block machine tires.
 - Tie machine down to truck or trailer.

SAFETY PRECAUTIONS

The following safety labels are mounted on the machine in the locations indicated. If any label becomes damaged or illegible, install a new label in its place.

WARNING LABEL – Machine emits toxic gases. Serious injury or death can result. Provide adequate ventilation.

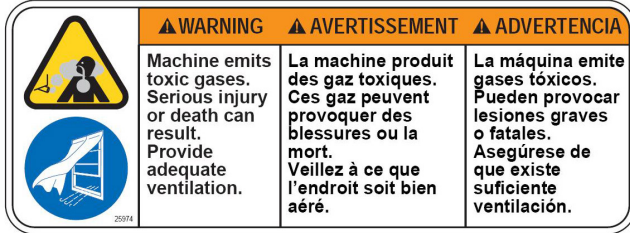

Located on the side of the operator compartment.

WARNING LABEL – Flammable materials can cause explosion or fire. Do not use flammable materials in tank.



Located on the tank.

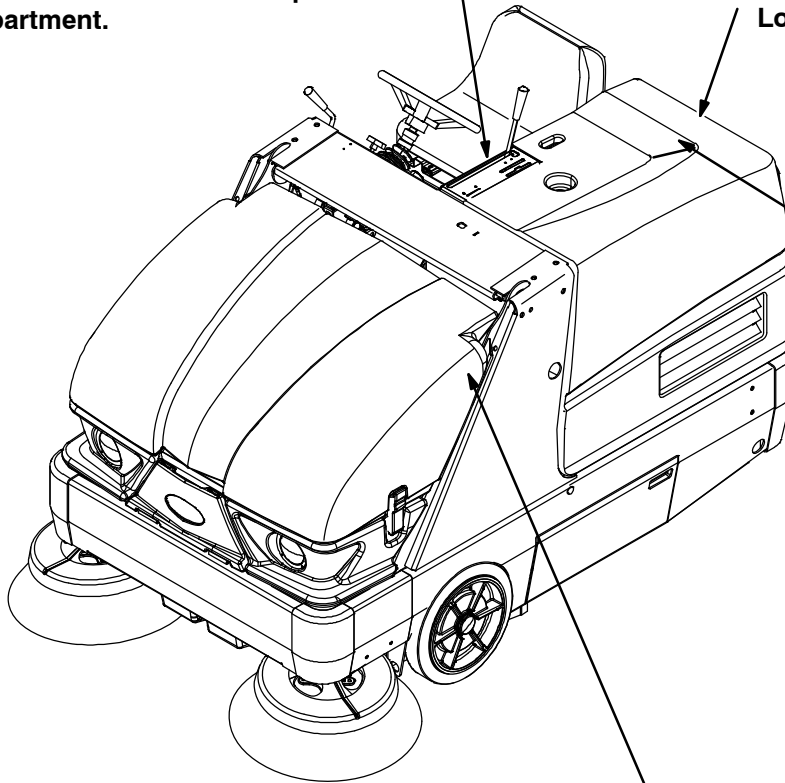

WARNING LABEL – Moving belt and fan. Stay away.



Located on engine belt guard.

WARNING LABEL – Machine can emit excessive noise. Hearing loss can result. Wear hearing protection.

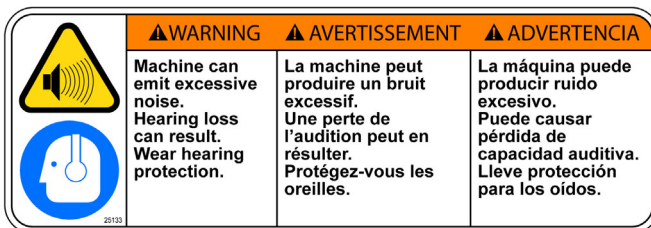



Located only on machines with cab option.

WARNING LABEL – Lift arm pinch point. Stay clear of hopper lift arms.



Located on both hopper lift arms.

WARNING LABEL – Raised hopper may fall. Engage hopper support pin.

 	▲ WARNING ▲ AVERTISSEMENT ▲ ADVERTENCIA		
	Raised hopper may fall. Engage hopper support bar.	La trémie levée peut tomber. Engagez la barre de support de la trémie.	La caja colectoras en posición elevada puede caer. Monte la barra de apoyo.

Located on the hopper support bar.

WARNING LABEL – Burn hazard. Hot surface. Do not touch.

	▲ WARNING Burn hazard. Hot surface. Do NOT touch.
	▲ AVERTISSEMENT Risque de brûlures. Surface chaude. Ne pas toucher.
	▲ ADVERTENCIA Peligro de quemaduras. Superficie caliente. NO tocar.

Located on the exhaust shield.



FOR SAFETY LABEL – Read manual before operating machine.

FOR SAFETY

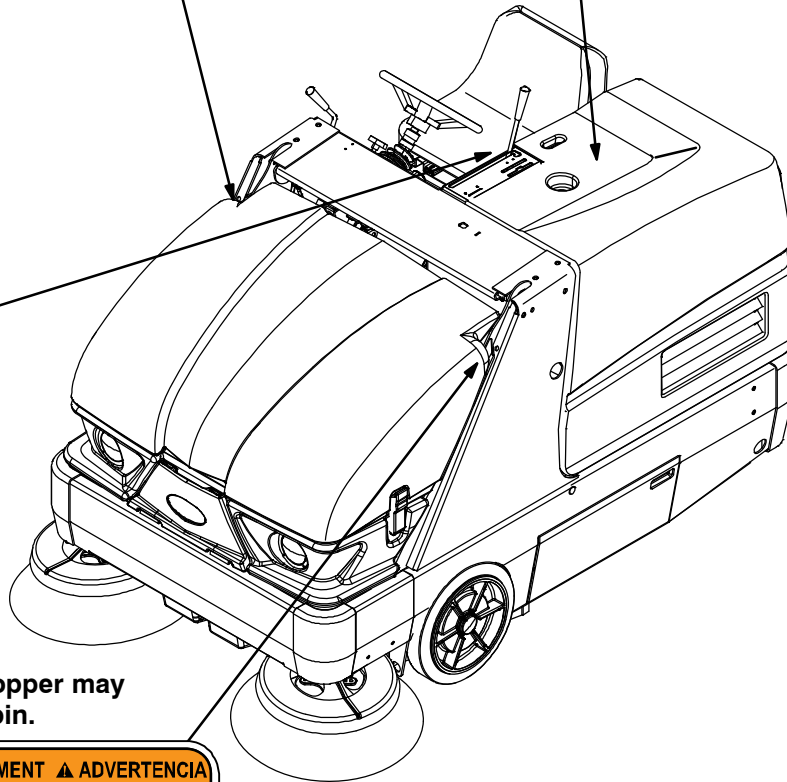
Read manual before operating machine.
POUR VOTRE SECURITE
Lisez le manuel avant d'utiliser la machine.
PARA SEGURIDAD
Lea el manual antes de operar la máquina.

Located on the side of the operator compartment.





WARNING LABEL – Raised hopper may fall. Engage hopper support pin.

 	▲ WARNING ▲ AVERTISSEMENT ▲ ADVERTENCIA		
	Raised hopper may fall. Engage hopper support bar.	La trémie levée peut tomber. Engagez la barre de support de la trémie.	La caja colectoras en posición elevada puede caer. Monte la barra de apoyo.

Located on the hopper lift arm.

WARNING LABEL – Accident may occur. Do not operate vacuum wand while driving.

 	▲ WARNING Accident may occur. Do not operate vacuum or blower wand while driving.	▲ MISE EN GARDE Un accident pourrait se produire. N'activez pas le manche aspirant ou soufflant lorsque vous conduisez.	▲ ADVERTENCIA Podría provocar accidentes. No utilice el tubo de aspiración ni el soplador mientras conduce.
---	---	---	---

Located on the optional vacuum wand.

354902

OPERATION

MACHINE COMPONENTS



1. Operator seat
2. Steering wheel
3. Instrument panel
4. Hopper cover
5. Side brush

6. Brush door
7. Fuel tank
8. Hopper access door
9. Main cover
10. Water tank (option)
11. HEPA filter (option)

CONTROLS AND INSTRUMENTS

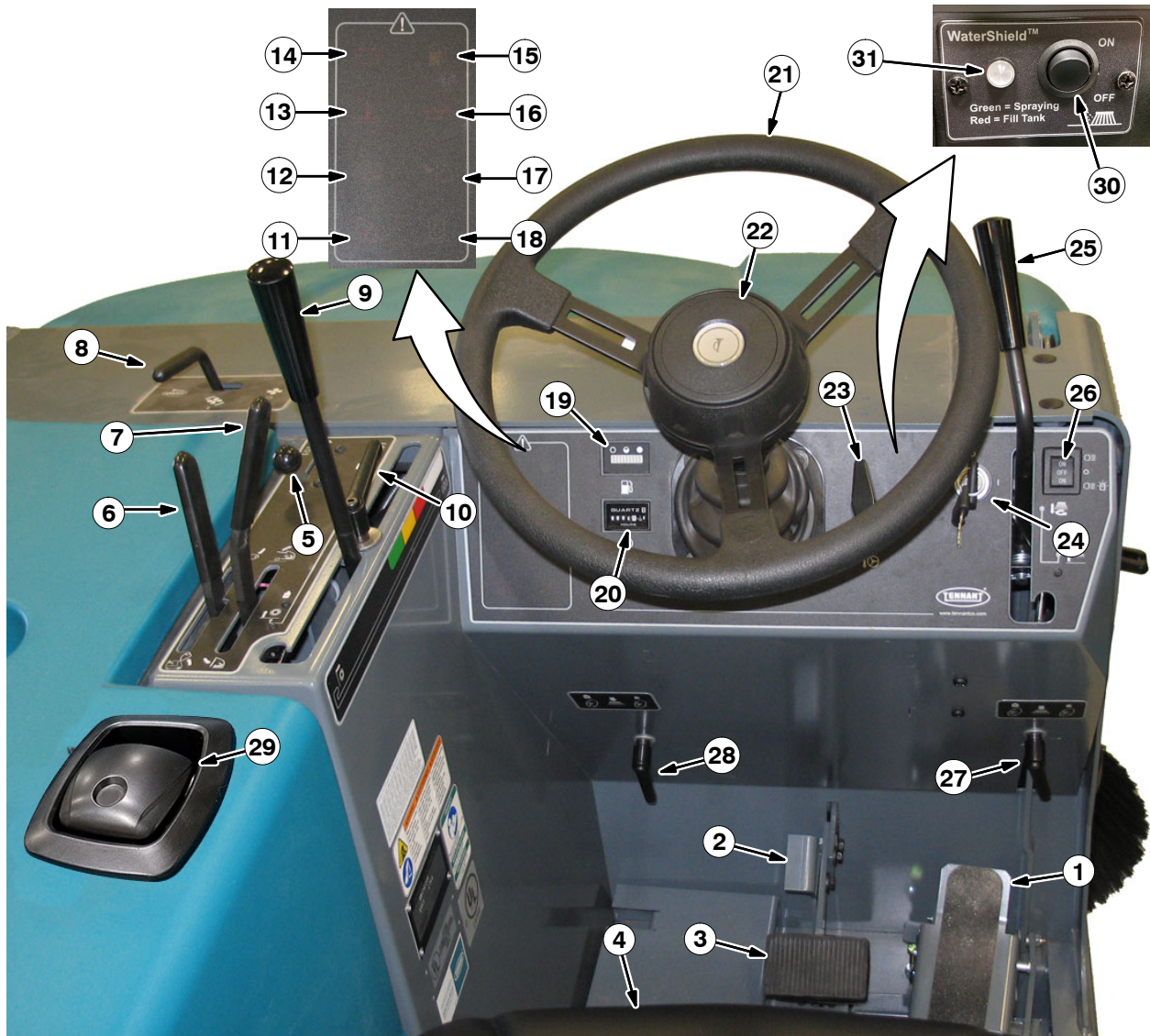

- | | |
|--|--|
| <ol style="list-style-type: none"> 1. Directional pedal 2. Parking brake pedal 3. Brake pedal 4. Seat adjustment lever 5. Throttle lever 6. Hopper raise / lower lever 7. Hopper door lever 8. Vacuum and filter shaker lever 9. Main brush lever 10. Main brush adjustment knob 11. Hopper temperature light – Thermo-Sentry 12. Clogged dust filter light 13. Engine water temperature light 14. Charging system light 15. Glow plug light 16. Engine oil pressure light | <ol style="list-style-type: none"> 17. Hopper door closed light 18. Clogged hydraulic filter light 19. Fuel level gauge 20. Hour meter 21. Steering wheel 22. Horn button 23. Steering wheel tilt handle 24. Ignition switch 25. Side brush lever 26. Operating / hazard lights switch 27. Right side brush adjustment knob 28. Left side brush adjustment knob (Dual side brush option only) 29. Main cover lever 30. Wet side brush dust control switch (option) 31. Wet side brush dust control indicator light (option) |
|--|--|

OPERATION

SYMBOL DEFINITIONS

These symbols identify controls, displays, and features on the machine.



Filter shaker



Vacuum fan on



Vacuum fan off



Fast engine speed



Idle engine speed



Hopper down



Hopper up



Hopper door open



Hopper door close (lever)



Main brush down and on



Main brush up and off



Battery charging system



Engine oil pressure



Thermo-Sentry



Clogged dust filter



Hopper door closed (light)



Clogged hydraulic filter



Glow plugs



Hourmeter



Steering wheel tilt



Off



On



Start



Horn



Operating lights



Hazard light



Engine water temperature



Side brush down and on



Side brush up and off



Side brush pressure



Parking brake



Brush pressure (Increase)



Brush pressure (Decrease)



Turn counterclockwise



Turn clockwise



Diesel fuel only



Wet side brush dust control (option)

OPERATION

OPERATION OF CONTROLS

DIRECTIONAL PEDAL

Press the top of the *Directional pedal* to move forward and the bottom of the pedal to move backward. The pedal returns to the neutral position when it is released.

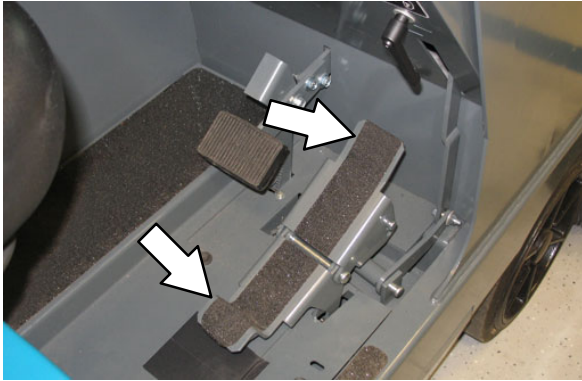

BRAKE PEDAL

Press the *Brake pedal* to stop the machine.

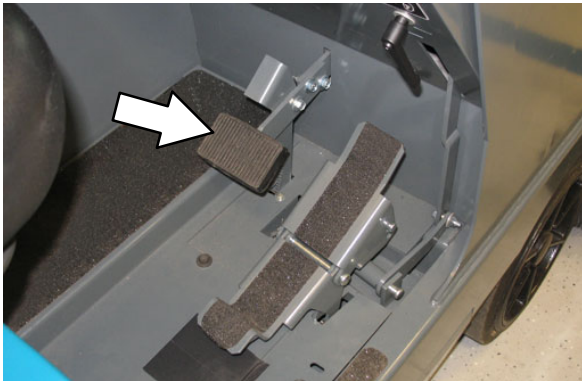

PARKING BRAKE PEDAL

Press the *Brake pedal* down as far as possible and use toe to lock the *Parking brake pedal* into place. Press the *Brake pedal* to release the parking brake. The *Parking brake pedal* will return to the unlocked position.

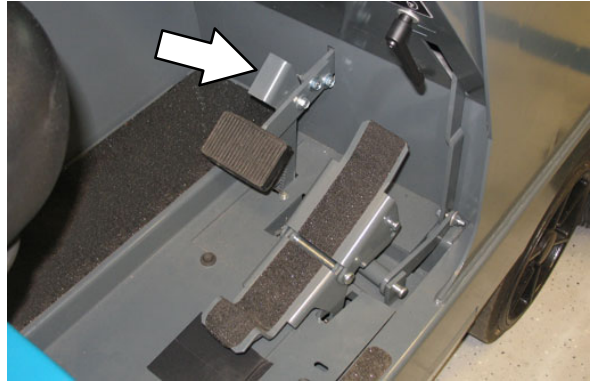

NOTE: If the operator is not in the seat, the parking brake must be engaged or the machine will automatically shut off after 2 seconds.

PARKING BRAKE LIGHT

The parking brake light comes on when the parking brake is engaged. Release the parking brake before operating the machine.

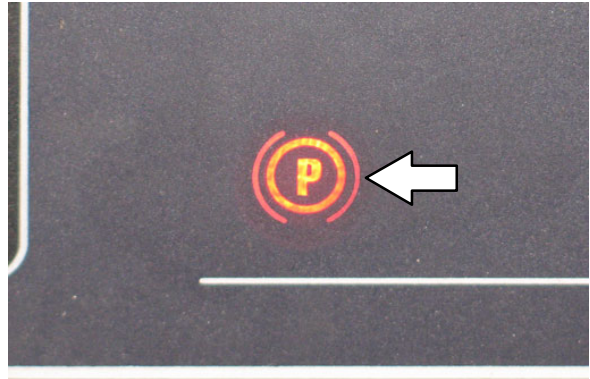

MAIN COVER LEVER

The main cover lever releases and locks the seat support.

Release: Pull the lever back and lift the main cover.

NOTE: Remove the optional Wet Side Brush Dust Control Water Tank before opening the main cover.

Lock: Close the main cover and release the lever to lock the cover in place.



STEERING WHEEL TILT HANDLE

The steering wheel tilt handle controls the angle of the steering wheel.

Adjust: Pull out the tilt handle, move the steering wheel up or down, and release the tilt handle.

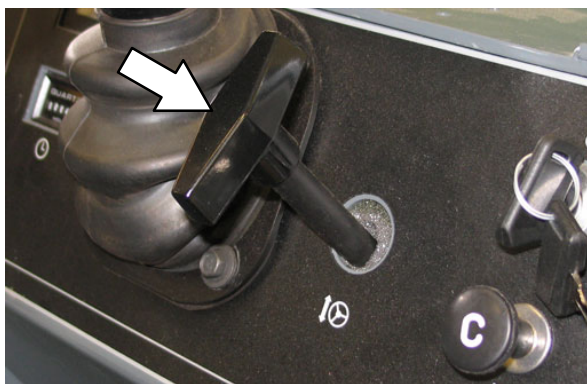

MAIN BRUSH ADJUSTMENT KNOB

The main brush adjustment knob changes the amount of contact the main brush has with the surface being swept. Refer to *ADJUSTING THE MAIN BRUSH WIDTH* section of this manual.

NOTE: The main brush adjustment knob can be repositioned if it interferes with any of the controls. Lift the knob, turn it to the desired position, and release it.



SIDE BRUSH ADJUSTMENT KNOB

The side brush adjustment knob changes the amount of contact the side brush has with the surface being swept. Refer to *ADJUSTING THE SIDE BRUSH PATTERN* section of this manual.

NOTE: The side brush adjustment knob can be repositioned. Lift the knob, turn it to the desired position, and release it.



OPERATION

CHARGING SYSTEM LIGHT

The charging system light comes on when the alternator is not operating within normal range; 13.5 to 14.5 V. If the light comes on, stop operating the machine. Contact a TENNANT service representative.

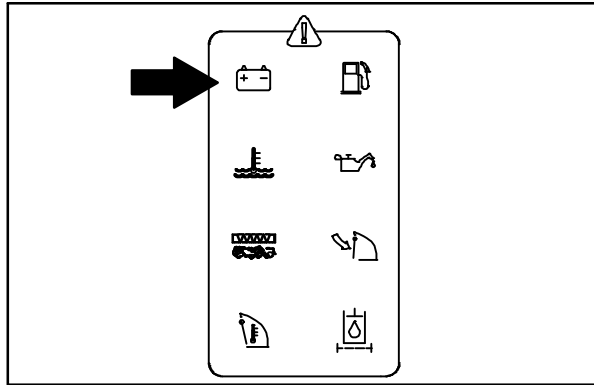

ENGINE WATER TEMPERATURE LIGHT

The engine water temperature light comes on when the temperature of the engine coolant is more than 113° C (235° F). If the light comes on, stop operating the machine. Contact a TENNANT service representative.

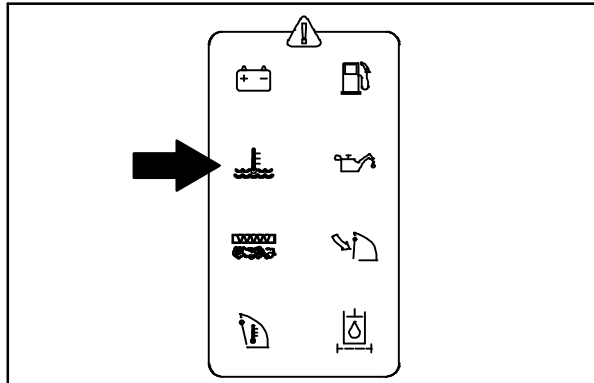

CLOGGED DUST FILTER LIGHT

The clogged dust filter light comes on when the hopper dust filter is clogged.

To clean the filter, hold the vacuum and filter shaker lever in the **Filter shaker** position. If the clogged dust filter light remains lit, manually clean the hopper dust filter. See *HOPPER DUST FILTER* in the *MAINTENANCE* section of this manual.

NOTE: The clogged dust filter light also comes on when the hopper door is closed and the vacuum fan is on.

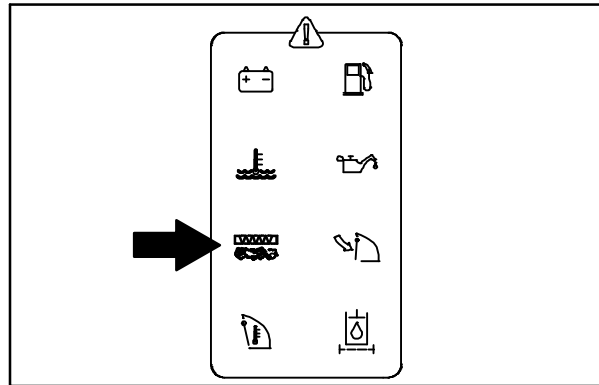

HOPPER TEMPERATURE LIGHT - THERMO-SENTRY

The hopper temperature light comes on when the Thermo-Sentry senses that there is excessive heat in the hopper, possibly from a fire. The Thermo-Sentry will also move the vacuum and filter shaker lever to the **Vacuum fan off** position. If this happens, stop the machine, eliminate the source of the heat, and return the lever to the **Vacuum fan on** position.

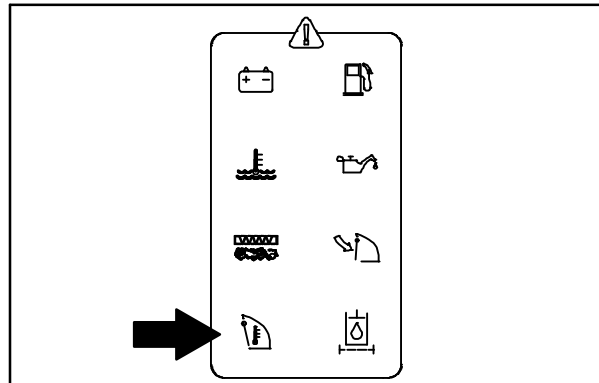

GLOW PLUG LIGHT

The glow plug light comes on when the ignition switch is turned counterclockwise to the **Glow plugs** position. The light will go out when the engine is ready to start.

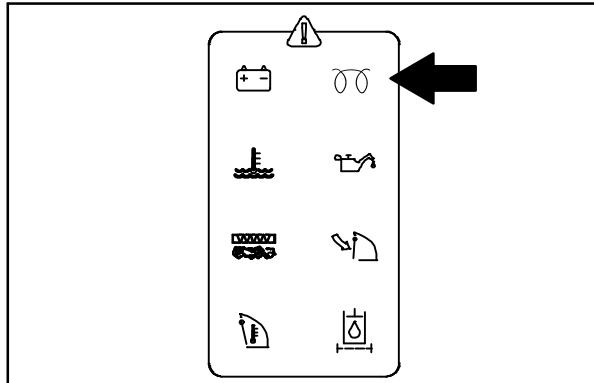

HOPPER DOOR CLOSED LIGHT

The hopper door closed light comes on when the hopper door is closed.

Make sure the hopper door is open all the way and the hopper door closed light is off, before sweeping.

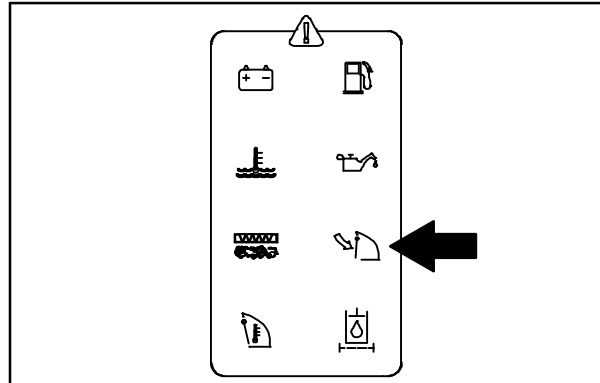

ENGINE OIL PRESSURE LIGHT

The engine oil pressure light comes on when the engine oil pressure falls below 40 kPa (5 psi). If the light comes on, stop operating the machine. Contact a TENNANT service representative.

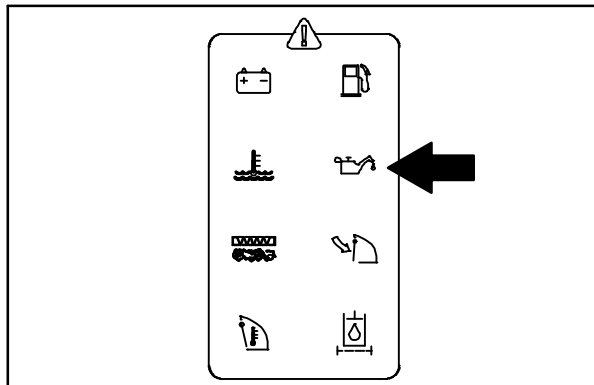

CLOGGED HYDRAULIC FILTER LIGHT

The clogged hydraulic filter light comes on when the hydraulic filter is clogged. If this light remains on, have the hydraulic filter changed as soon as possible.

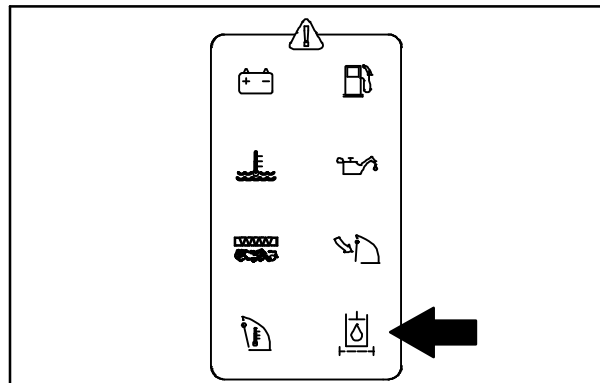

OPERATION

FUEL LEVEL GAUGE

The fuel level gauge indicates how much fuel is in the fuel tank.

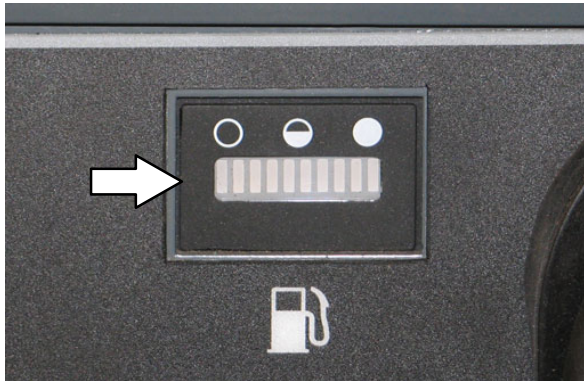

HOUR METER

The *Hour meter* records the hours the machine was operated. Use this information to determine machine service intervals.

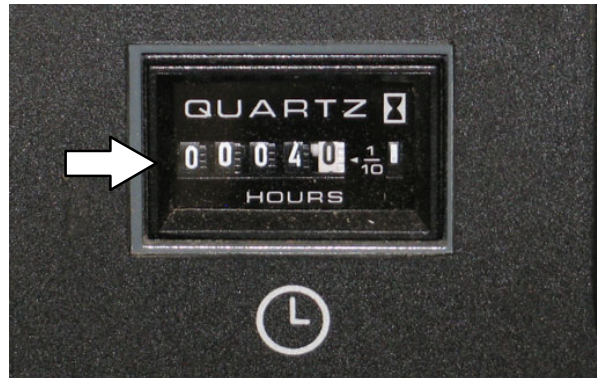

OPERATING / HAZARD LIGHTS SWITCH

The operating / hazard lights switch powers on and off the headlights and taillights and the optional hazard light.

Operating lights on: Press the top part of the switch.

Operating / Hazard lights on (Optional): Press the bottom part of the switch.

Off: Place the switch in the middle position.

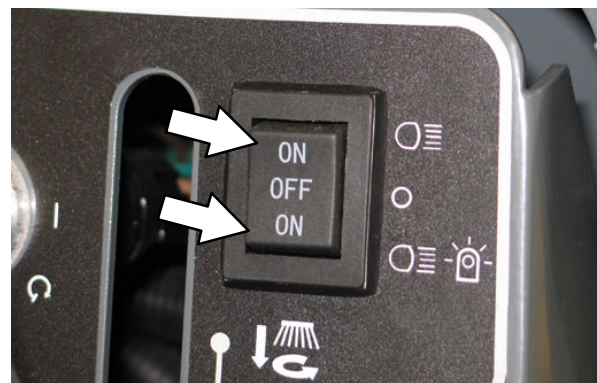

OPERATOR SEAT

The front-to-back adjustment lever adjusts the seat position.

**DELUXE SUSPENSION SEAT (OPTION)**

The operator seat has three adjustments: backrest angle, operator weight, and front to back.

The operator's weight adjustment lever controls the seat weight adjustment. The lever has three positions: lightweight, middleweight, and heavyweight.

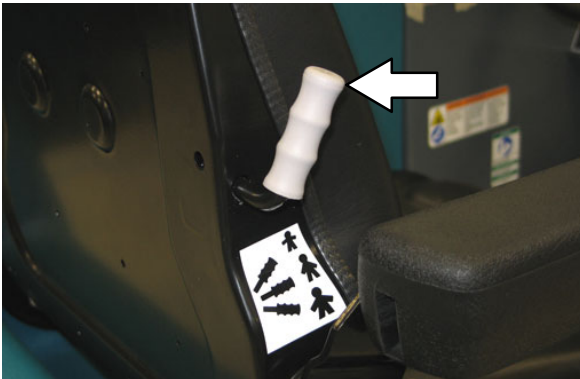

The backrest adjustment knob adjusts the angle of the backrest.

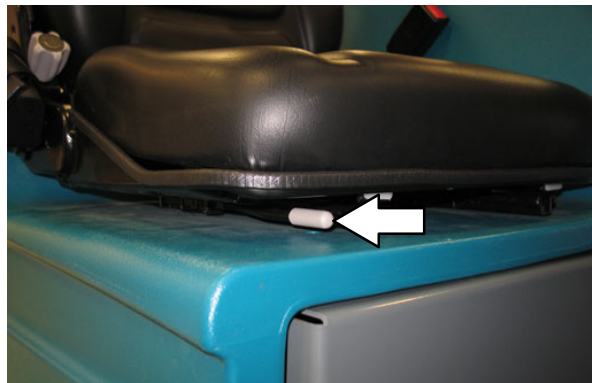

The front-to-back adjustment lever adjusts the seat position.

**SEAT BELTS (OPTION)**

FOR SAFETY: Before starting machine, adjust seat and fasten seat belt (if equipped).



HOW THE MACHINE WORKS

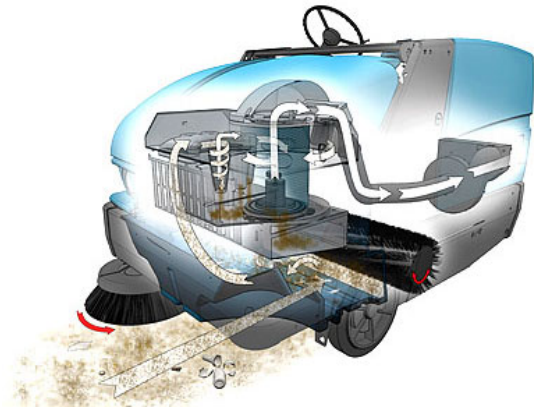

The steering wheel controls the direction of machine travel. The directional pedal controls the speed and forward/reverse direction. The brake pedal slows and stops the machine.

The side brush sweeps debris into the path of the main brush. The main brush sweeps debris from the floor into the hopper. The vacuum system pulls dust and air through the hopper and the dust control system.

The machine also has a wet side brush dust control option to help contain dust.

The machine also has an optional dry sweeping HEPA filtration system to help contain fine dust.

When sweeping is finished, shake the dust filter and empty the hopper.

BRUSH INFORMATION

For best results, use the correct brush type for the cleaning application.

NOTE: The amount and type of soilage play an important role in determining the type of brushes to use. Contact a Tennant representative for specific recommendations.

Polypropylene Sand Wedge Main Brush – Recommended for heavy accumulation of sand and other fine particles.

Polypropylene Window Main Brush – Recommended for light litter, especially on smooth floors.

Polypropylene 8-double row Main Brush – Recommended for general sweeping applications.

Polypropylene and Wire 8-double row Main Brush – Recommended for general sweeping and slightly impacted debris.

Polyester 8-double row Main Brush – Recommended for general sweeping, especially on rough or irregular surfaces. Nylon has a long wear life.

Polyester Full Fill Main Brush – Recommended for accumulation of sand and other fine particles. Nylon has a long wear life.

Natural Fiber 8-double row Main Brush – Recommended for accumulation of sand and other very fine particles.

Polypropylene Side Brush – Recommended for general sweeping of light to medium debris.

Nylon Side Brush – Recommended for general sweeping of rough or irregular surfaces. Nylon has a long wear life.

Flat Wire Side Brush – Recommended for outdoor curb-side sweeping where dirt is heavy or compacted.

WHILE OPERATING THE MACHINE

Pick up oversized debris before sweeping. Pick up wire, string, twine, large pieces of wood, or any other debris that could become wrapped around or tangled in the brushes.

NOTE: Debris can be placed in the hopper through the hopper access door on the front of the hopper.

Drive as straight a path as possible. Avoid bumping into posts or scraping the sides of the machine. Overlap the sweep paths by several centimeters (a few inches).

Avoid turning the steering wheel too sharply when the machine is in motion. The machine is very responsive to the movement of the steering wheel. Avoid sudden turns, except in emergencies.

Adjust the machine speed and brush pressure. Use the lowest brush pressure for best performance.

Keep the machine moving to prevent damaging floor finishes.

If poor cleaning performance is observed, stop cleaning and refer to *MACHINE TROUBLESHOOTING* in this manual.

Perform the Daily Maintenance Procedures after each use (see *MACHINE MAINTENANCE* in this manual).

Drive the machine slowly on inclines. Use the brake pedal to control machine speed on descending inclines. Sweep with the machine up inclines rather than down inclines.

FOR SAFETY: When using machine, go slowly on inclines and slippery surfaces. Do not sweep on ramp inclines that exceed 14% grade or transport (GVWR) on ramp inclines that exceed 17.6% grade.

Do not operate machine in areas where the ambient temperature is above 43° C (110° F). Do not operate sweeping functions in areas where the ambient temperature is below freezing 0° C (32° F).

PRE-OPERATION CHECKLIST

- Check the machine for fluid leaks.
- Check the main sweep brush for damage and wear . Remove string, banding, plastic wrap, or other debris wrapped around the brush.
- Check the main brush compartment right skirt for damage and wear.
- Check the dry dust control (Option) skirts for damage and wear.
- Check the side brush(es) for damage and wear . Remove string, banding, plastic wrap, or other debris wrapped around the brush.
- Check the main brush compartment left skirt for damage and wear.
- Check the air filter indicator.
- Check the engine oil level.
- Check the engine coolant level.
- Check the radiator fins and cooling fan screen for debris.
- Check the hydraulic fluid level.
- Check for rubbing hoses or wires and leaks or obstructions.
- Check the horn, headlights, taillights, safety lights, and backup alarm (if equipped).
- Check all controls for proper operation.
- Check hopper skirt and brush compartment skirts for damage and wear.
- Check the brakes and steering for proper operation.
- Check the service records to determine maintenance requirements.
- Clean hopper.
- Check the cyclonic chamber and dust tray flaps for wear, damage, and ensure they open (HEPA option).

STARTING THE MACHINE

1. Sit in the operator's seat and engage the brakes with the directional pedal in neutral.

FOR SAFETY: When starting machine, keep foot on brake and directional pedal in neutral.

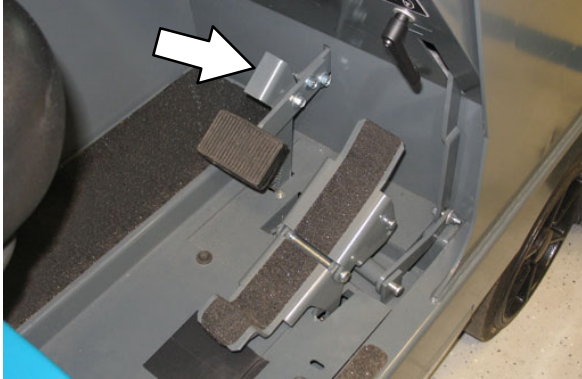

2. Move the throttle lever back into the **Idle engine speed** position.

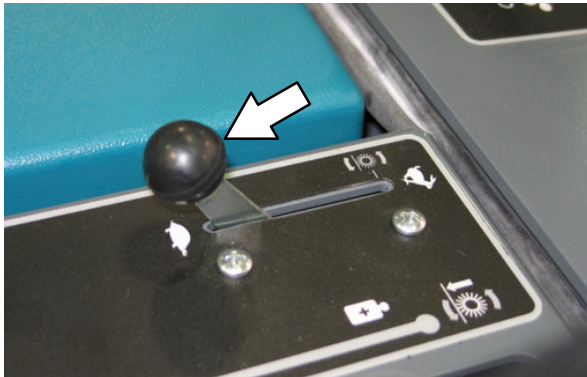

3. Turn the ignition switch key counterclockwise. The glow plug light will come on. When the glow plug light goes out, the engine is ready to start.



4. Turn the ignition switch key clockwise until the engine starts.

NOTE: Do not operate the starter motor for more than 10 seconds at a time or after the engine has started. Allow the starter to cool between starting attempts or damage to the starter motor may occur.



5. Allow the engine and hydraulic system to warm up three to five minutes.

WARNING: Machine emits toxic gases. Severe respiratory damage or asphyxiation can result. Provide adequate ventilation. Consult with your regulatory authorities for exposure limits. Keep engine properly tuned.

6. Move the throttle lever all the way forward into the **Fast engine speed** position.

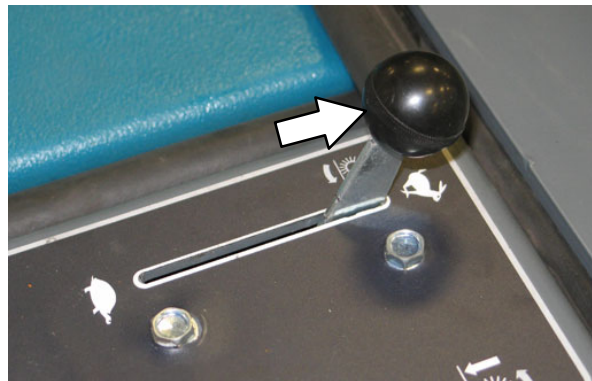

OPERATION

7. Release the machine parking brake.

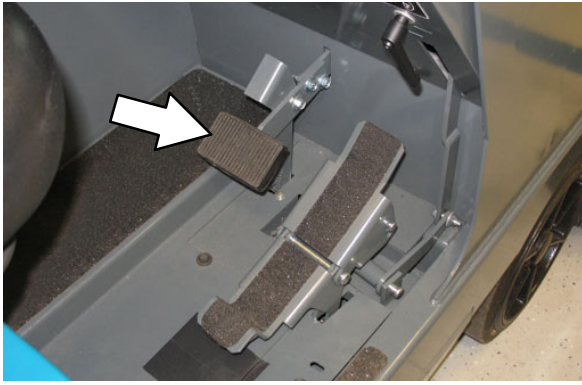

4. Set the machine parking brake.

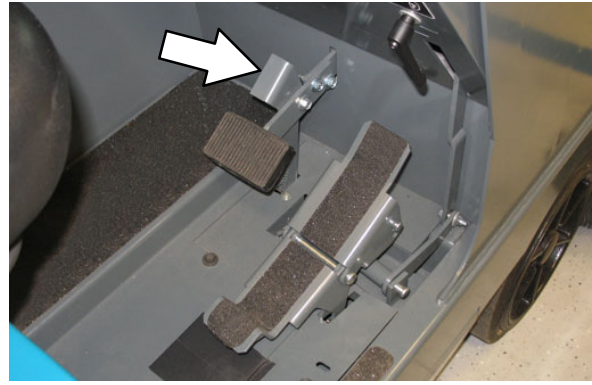

8. Drive the machine to the area to be cleaned.

5. Turn the ignition switch key counterclockwise to stop the machine. Remove the switch key.

TURNING OFF THE MACHINE

1. Stop sweeping.
2. Take your foot off the directional pedal. Step on the brake pedal.

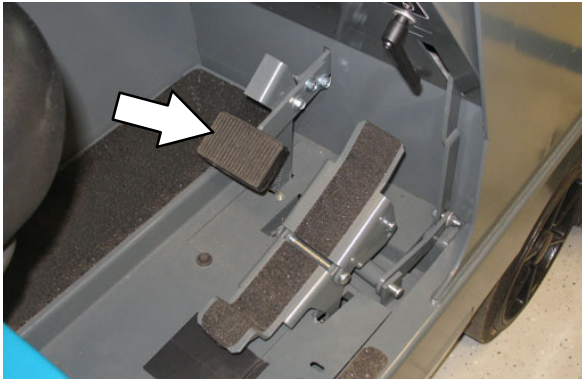

FOR SAFETY: Before leaving or servicing machine, do not park near combustible materials, dust, gases, or liquids. Stop on level surface, set parking brake, turn off machine, and remove key.

3. Move the throttle lever back into the **Idle engine speed** position.

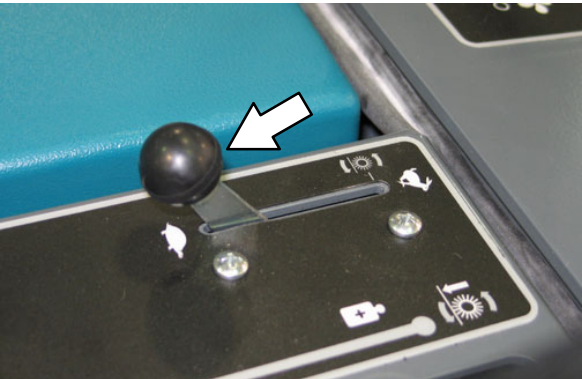

SWEEPING

1. Ensure that the hopper is completely lowered.
2. Move the throttle lever all the way forward into the **Fast engine speed** position.

*NOTE: Only operate the throttle all the way open in the **Fast engine speed** position when sweeping. Operating the throttle at any other position will reduce performance.*

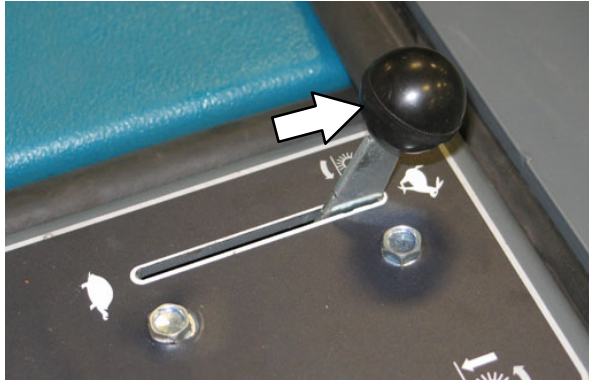

3. Push the hopper door lever forward to open the hopper door.



4. Move the vacuum and filter shaker lever to the **Vacuum fan on** position.



NOTE: The vacuum fan duct should be off when sweeping wet debris.

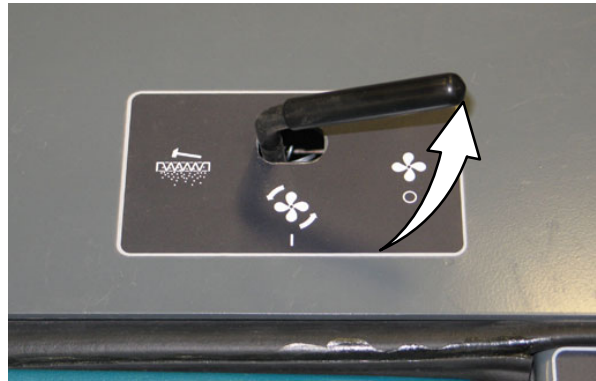

*NOTE: Excessive heat in the hopper will cause the Thermo Sentry to move the vacuum and filter shaker lever to the **Vacuum fan off** position. It will also make the hopper temperature light come on. If this happens, stop the machine, eliminate the source of the heat, and return the lever to the **Vacuum fan on** position.*

OPERATION

- Place the main brush lever in the right **Main brush down and on** position. The brush will automatically start rotating.

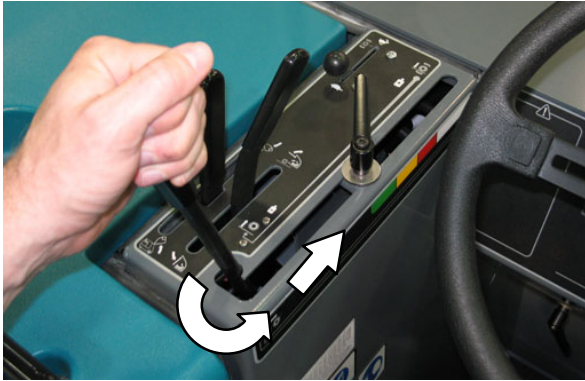

- Place the main brush lever in the left **Main brush up and off** position.



- Place the side brush lever in the left **Side brush down and on** position. The brush will automatically start rotating.

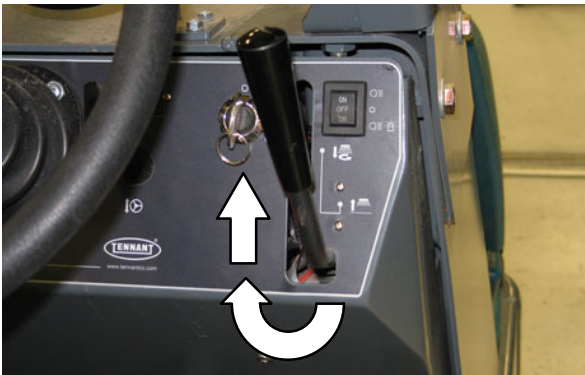

- Pull and hold the hopper door lever back until the hopper door closed light comes on.

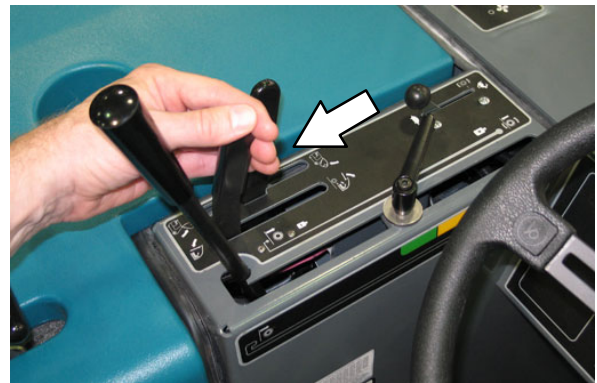

- Sweep as needed.

STOP SWEEPING

- Place the side brush lever in the right **Side brush up and off** position.



- Shake the dust filter by holding the vacuum and filter shaker lever in the **Filter shaker** position for 30 seconds.



EMPTYING THE HOPPER

1. Stop sweeping and shake the filter.
2. Pull and hold the hopper door lever back until the hopper door closed light comes on.



3. Slowly drive the machine to the debris site or debris container.
4. Pull and hold the hopper raise / lower lever back and raise the hopper to the desired height. Release the lever into the **Hold** position.



FOR SAFETY: When using machine, do not raise hopper when machine is on an incline. Make sure adequate clearance is available before raising hopper.

NOTE: Be aware that the minimum ceiling height needed to high dump the hopper is 2490 mm (98 in).

5. Drive the machine up to the debris container. Position the hopper over the debris container.

FOR SAFETY: When using machine, move machine with care if hopper is raised.

6. Move the vacuum and filter shaker lever into the **Vacuum fan off** position.

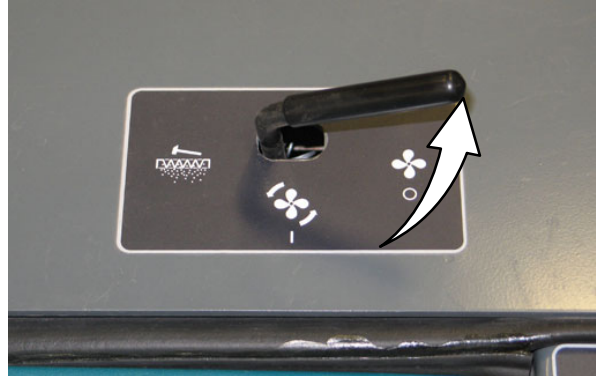

7. Push the hopper door lever forward to empty the hopper.



OPERATION

8. Pull and hold the hopper door lever back until the hopper door closed light comes on.



11. Push the hopper door lever forward to open the hopper door.



9. Slowly back the machine away from the debris site or debris container.

FOR SAFETY: When using machine, use care when reversing machine.

10. Push and hold the hopper raise / lower lever forward to lower the hopper. Release the lever into the **Hold** position.



12. Move the vacuum and filter shaker lever into the **Vacuum fan on** position.



ENGAGING HOPPER SUPPORT BAR

1. Set the machine parking brake.

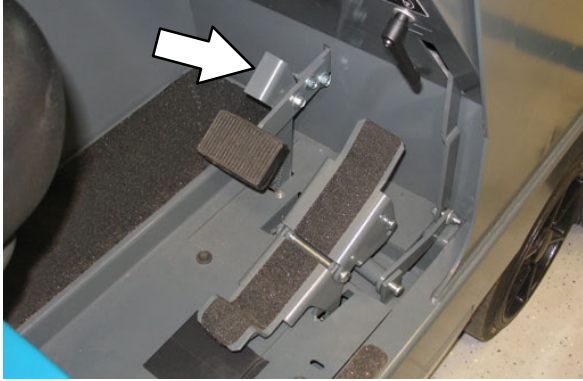

FOR SAFETY: When starting machine, keep foot on brake and directional pedal in neutral.

2. Start the machine.

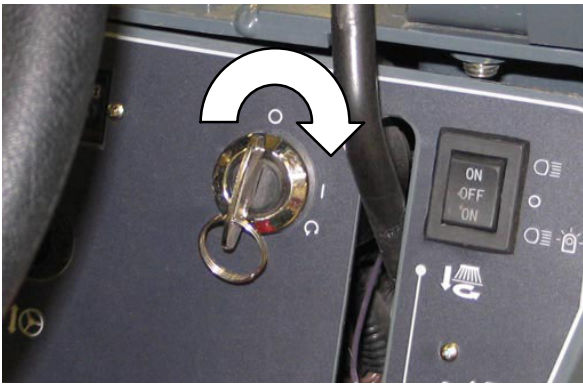

3. Move the throttle lever all the way forward into the **Fast engine speed** position.

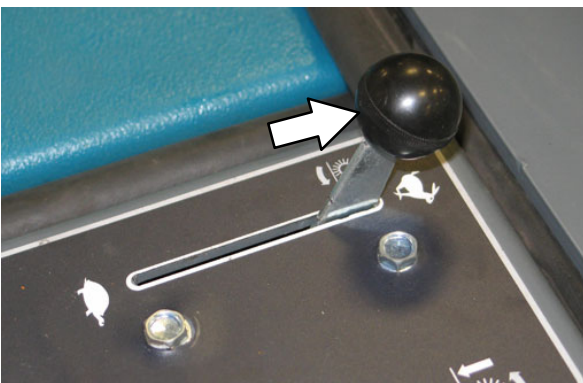

4. Pull and hold the hopper raise / lower lever back and raise the hopper to the desired height. Release the lever into the **Hold** position.

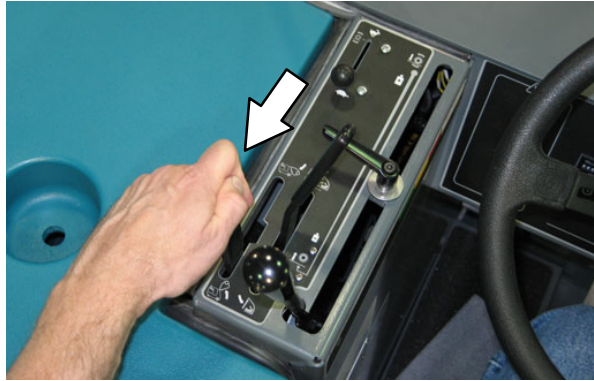

FOR SAFETY: When using machine, make sure adequate clearance is available before raising hopper.

NOTE: Be aware that the minimum ceiling height needed to high dump the hopper is 2490 mm (98 in).

5. Lower and position the hopper support bar onto the support bar stop.

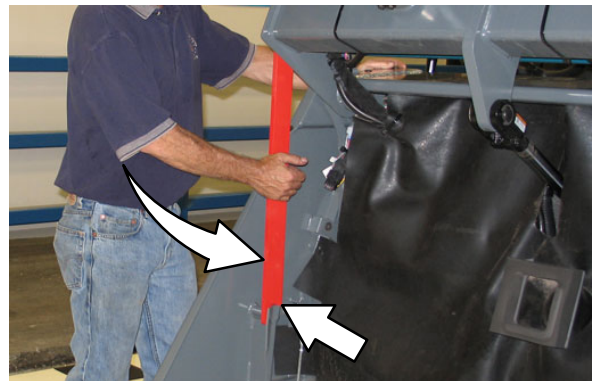

WARNING: Raised hopper may fall. Engage hopper support bar.



OPERATION

6. Slowly lower the hopper so the hopper support bar rests on the support bar stop.



WARNING: Lift arm pinch point. Stay clear of hopper lift arms.

7. Move the throttle lever back into the **Idle engine speed** position.

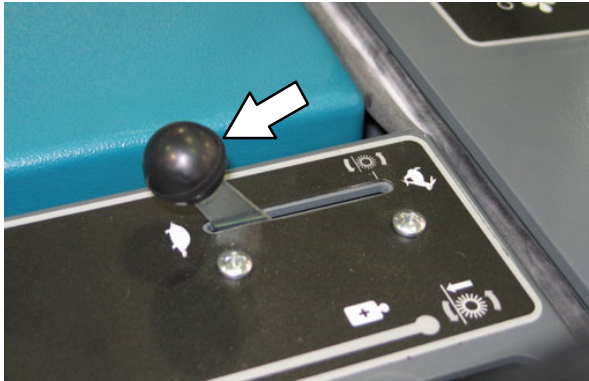

8. Shut the machine off.



DISENGAGING HOPPER SUPPORT BAR

1. Start the machine.

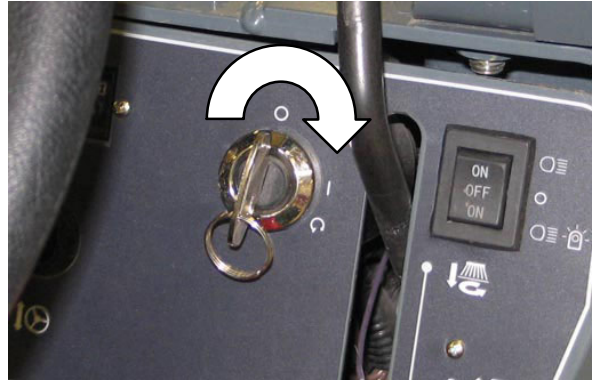

FOR SAFETY: When starting machine, keep foot on brake and directional pedal in neutral.

2. Move the throttle lever all the way forward into the **Fast engine speed** position.

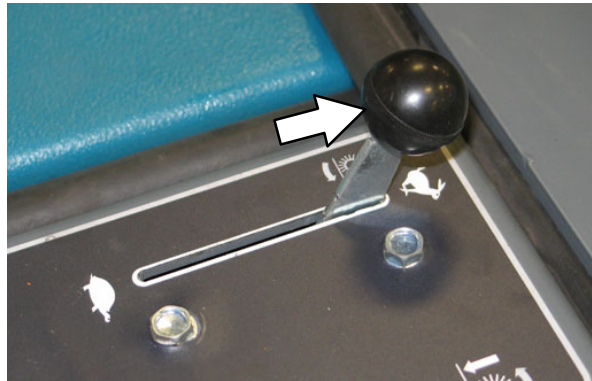

3. Pull and hold the hopper raise / lower lever back and raise the hopper slightly. Release the lever into the **Hold** position.



4. Put the support bar in its storage position

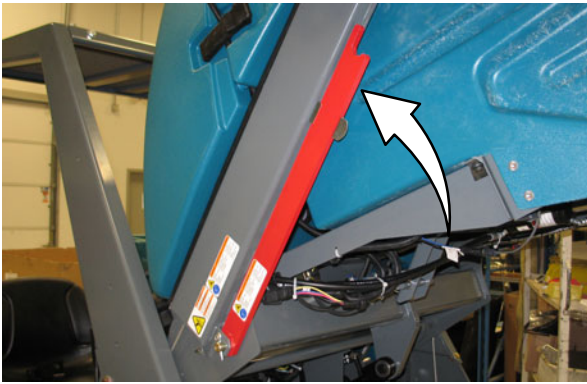

7. Shut the machine off.

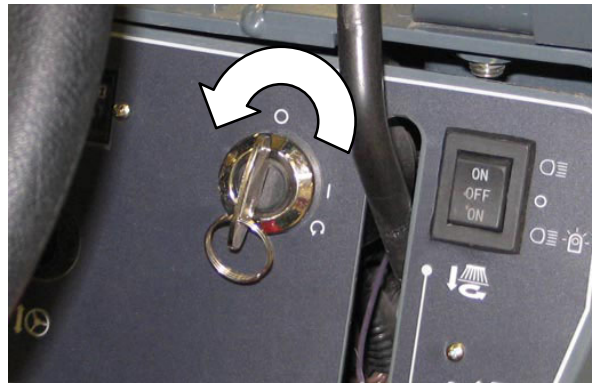

! **WARNING: Lift arm pinch point. Stay clear of hopper lift arms.**

5. Push and hold the hopper raise / lower lever forward to lower the hopper. Release the hopper lever into the **Hold** position.

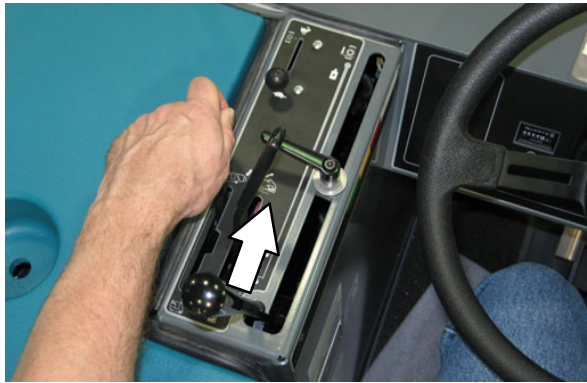

6. Move the throttle lever back into the **Idle engine speed** position.

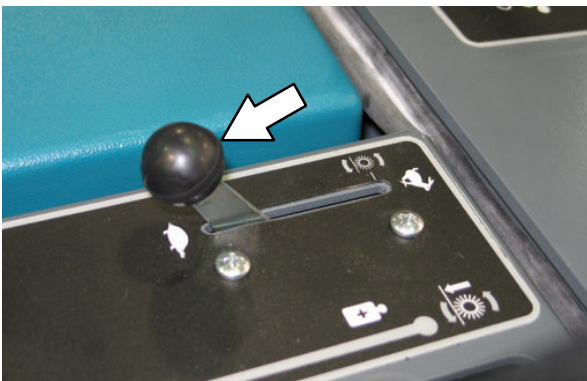

OPERATION

OPTIONS

VACUUM WAND

The vacuum wand uses the machine's vacuum system. The vacuum hose and wand allow pick-up of debris that is out of reach of the machine.

1. Stop the machine within reach of the area to be vacuumed.
2. Set the machine parking brake and turn the machine off.

FOR SAFETY: Before leaving or servicing machine, stop on level surface, set parking brake, and turn off machine.

NOTE: If the operator is not in the seat, the parking brake must be engaged or the machine will automatically shut off after 2 seconds.

3. Open the hopper cover and prop the cover open.
4. Remove the vacuum wand from the mounting clips and the hose from the storage compartment.

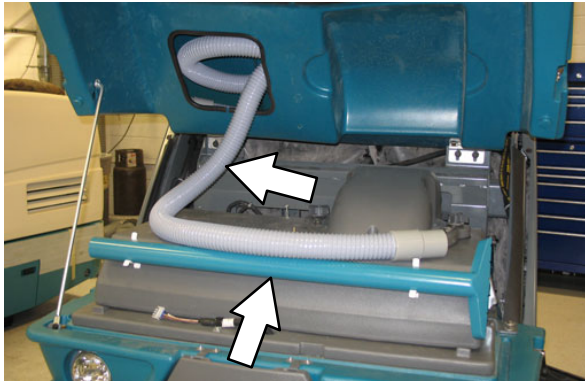

5. Connect the vacuum hose to the vacuum wand.



6. Open the access door located at the front of the machine.



7. Connect the other end of the vacuum hose to the hopper hose connector.

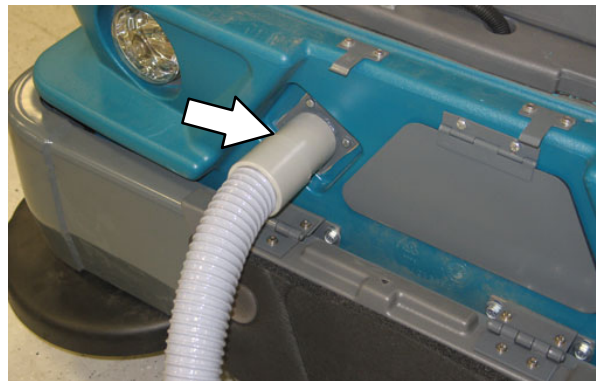

8. Start the engine.

FOR SAFETY: When starting machine, keep foot on brake and directional pedal in neutral.

9. Move the throttle lever all the way forward into the **Fast engine speed** position.

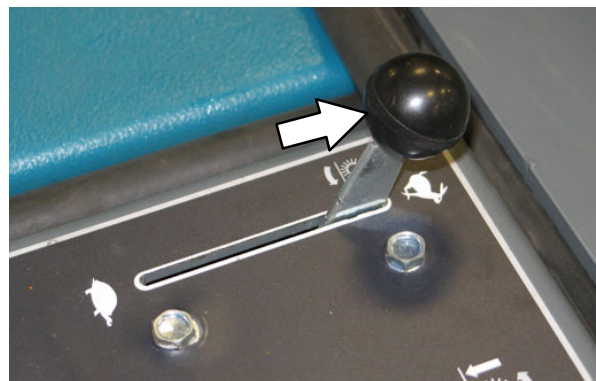

10. Pull and hold the hopper door lever back until the hopper door closed light comes on.



11. Move the vacuum and filter shaker lever into the **Vacuum fan on** position.

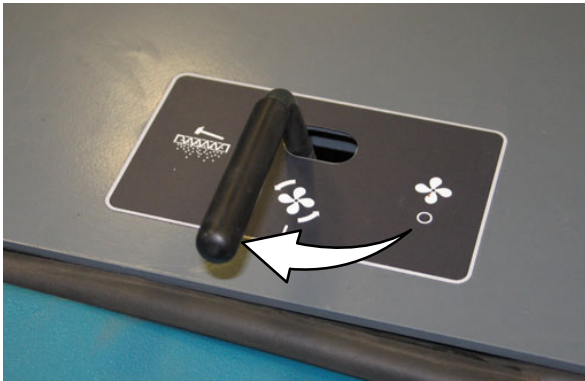

12. Vacuum the area as needed.

WARNING: Accident may occur. Do not operate vacuum wand while driving.

13. When finished, push the hopper door lever forward into the **Hopper door open** position to open the hopper door.
14. Shut the machine off.
15. Remove the vacuum hose from the hopper connection.
16. Close the access door.
17. Disconnect the vacuum hose from the vacuum wand.
18. Put the vacuum wand in the mounting clips and the hose into the storage compartment.
19. Close the hopper cover.

TOWER BUMPERS (OPTION)

The tower bumpers help protect the machine from being damaged. Open the tower bumpers before opening the seat support.

To open the bumpers:

1. Pull the pin from the bracket and the bumper.

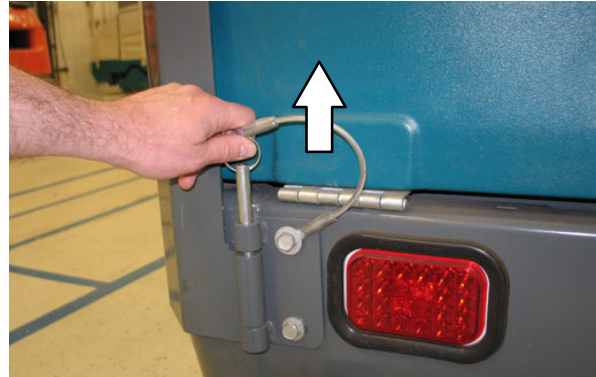

2. Open the bumper.

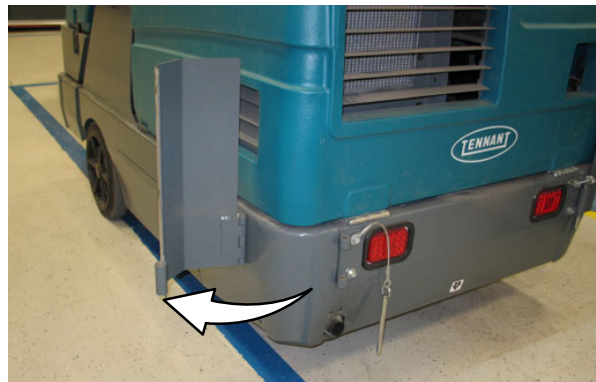

3. Close and secure the tower bumpers before operating the machine.

OPERATION

WET SIDE BRUSH DUST CONTROL (OPTION)

The *wet side brush dust control* is useful in dusty conditions to control the dust created by the side brush (es).

1. Set the Parking brake.

FOR SAFETY: Before leaving or servicing machine, stop on level surface, set parking brake, turn off machine and remove key.

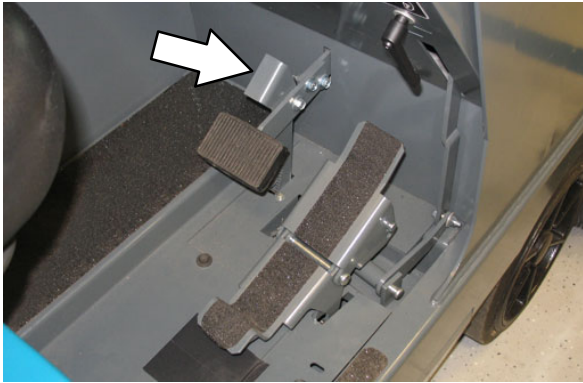

2. Remove the water tank cap. Fill the tank with water. The water level can easily be seen on the side of the water tank. Replace the water tank cap.

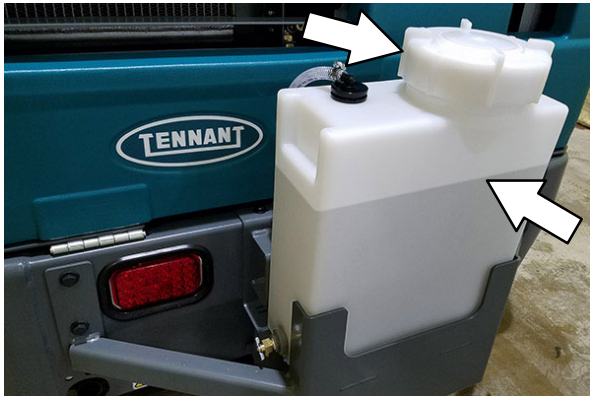

WARNING: Flammable materials can cause explosion or fire. Do not use flammable materials in tank.

Use the *wet side brush dust control switch* to turn the water sprayer on and off.

Bottom (OFF) position: Water sprayer is off.

Top (ON) position: Water will spray when the machine is moving. The indicator light will display green.

NOTE: if the indicator light displays red, the water tank is empty and needs to be filled.



MACHINE TROUBLESHOOTING

Problem	Cause	Remedy	
Excessive dusting	Hopper door partially or completely closed	Open hopper door	
	Vacuum fan off	Move vacuum and filter shaker lever to Vacuum fan on position	
	Hopper dust filter clogged	Shake and/or clean or replace dust filter	
	Brush skirts and dust seals worn, damaged, out of adjustment	Replace or adjust brush skirts or dust seals	
	Cyclones dirty / clogged	Clear blockage from cyclones	
	Vacuum hose damaged	Replace vacuum hose	
	Vacuum fan failure		Ensure thermo Sentry wires are connected
			Contact TENNANT service personnel
	Thermo-Sentry tripped	Allow Thermo-Sentry to cool	
	Water tank empty (option)	Fill water tank	
	Wet side brush dust control switch not turned on (option)	Turn on the wet side brush dust control switch	
	Wet side brush dust control filter clogged (option)	Clean or replace filters	
	Wet side brush dust control nozzle clogged (option)	Clean nozzle	
Poor sweeping performance	Brush bristles worn	Replace brushes	
	Main and side brushes not adjusted properly	Adjust main and side brushes	
	Debris caught in main brush drive mechanism	Remove debris from the drive mechanism.	
	Hopper door partially or completely closed	Open hopper door	
	Hopper full	Empty hopper	
	Recirculation flap damaged	Replace flap	
	Wrong sweeping brush	Contact TENNANT representative for recommendations	
	Hopper lip skirts worn or damaged	Replace lip skirts	
	Side brush drive failure	Contact TENNANT service personnel	
	Main brush drive failure	Contact TENNANT service personnel	

OPERATION

HEPA FILTER SYSTEM TROUBLESHOOTING TABLE

Refer to the troubleshooting table below and the troubleshooting procedures if excessive dust is noted on machines equipped with the HEPA filter during machine operation.

STEP	ACTION	NOT DUSTING	DUSTING
1	* Use electric shaker to shake primary dust filter * Empty hopper	Resume Sweeping	Proceed to Step 2
2	* Inspect seal at front hopper access door	Resume Sweeping	Proceed to Step 3
3	* Remove primary filter and place in plastic bag. * Manually tap filter to remove dust. * Inspect seal on filter cover * Inspect seal to vacuum fan inlet	Resume Sweeping	Proceed to Step 4
4	* Open upper cyclone clean out door and inspect * Vacuum out dust (HEPA certified vacuum) if buildup is heavy	Resume Sweeping	Proceed to Step 5
5	* Raise hopper to inspect cyclone and primary dust filter debris tray flaps * Flaps must move freely * Remove debris buildup if flap movement is restricted	Resume Sweeping	Proceed to Step 6
6	* Inspect side brush dust control skirts for damage and adjustment	Resume Sweeping	Proceed to Step 7
7	* Raise hopper to inspect wheel pocket skirts * Open side brush doors and inspect skirts * Inspect sweep chamber skirts	Resume Sweeping	Proceed to Step 8
8	* Inspect HEPA filter box inlet hose. * Check for rips, attachment, and restrictions inside the hose	Resume Sweeping	Proceed to Step 9
9	* Check primary filter seal height on shaker plate * Measure height from shaker plate mount bracket to top of lower cyclone box	Resume Sweeping	Adjust dust filter seal height

MAINTENANCE

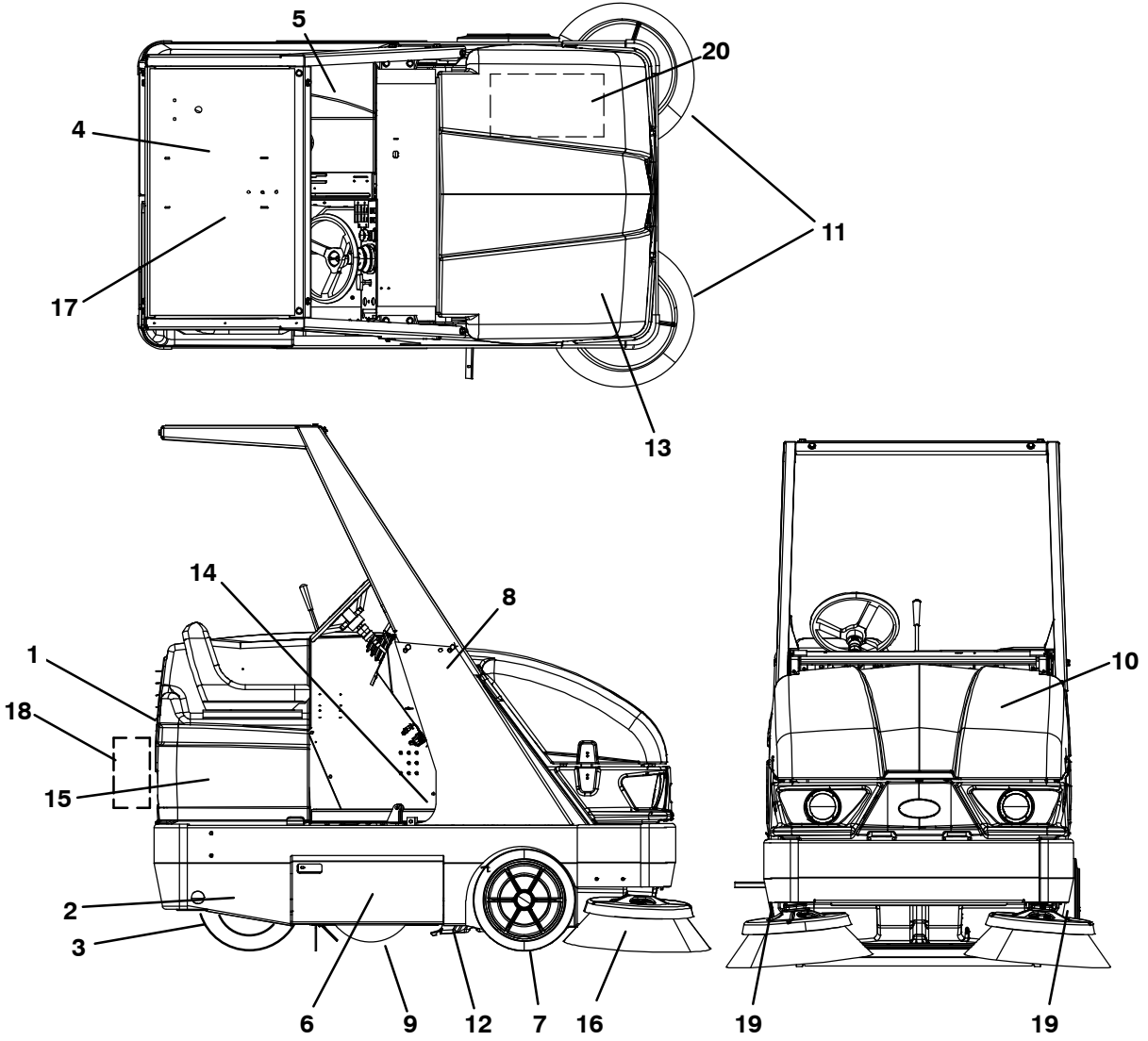

MAINTENANCE

MAINTENANCE CHART

The table below indicates the *Person Responsible* for each procedure.

O = Operator.

T = Trained Personnel.

 = Indicates unique maintenance schedule for machines equipped with HEPA filtration system.

Interval	Person Resp.	HEPA	Non-HEPA	Key	Description	Procedure	Lube/ Fluid	No. of Service Points
Daily/ 8 Hours	O			1	Radiator	Check fins and cooling fan screen. Clean as necessary	-	1
						Check coolant level	WG	1
	O			4	Engine	Check oil level	EO	1
						Check air filter indicator	-	1
	O			6	Main brush compartment skirts	Check for damage, wear and adjustment	-	All
	O			12	Hopper lip skirts	Check for damage, wear and adjustment	-	3
	O			9	Main brush	Check for damage or wear	-	1
	O			11	Side brush(es)	Check for damage or wear	-	1
	O			15	Hydraulic fluid reservoir	Check fluid level	HYDO	1
	O			10	Hopper dust filter	Shake	-	1
	O		*	10	Hopper	Inspect / Clean	-	1
	O	*		10	Hopper	Clean / Rinse	-	1
	O	*		20	Cyclonic chamber and dust tray flaps	Check for wear, damage, and ensure flaps are fully open and free of debris buildup	-	All

The table below indicates the *Person Responsible* for each procedure.

O = Operator.

T = Trained Personnel.

 = Indicates unique maintenance schedule for machines equipped with HEPA filtration system.

Interval	Person Resp.	HEPA	Non-HEPA	Key	Description	Procedure	Lube/Fluid	No. of Service Points
50 Hours	O	*		10	Hopper dust filter & seals	Inspect for buildup of dust and lint/fiber on dirty side of filter. Inspect for damaged seals and dust leaks across seals	-	1
	O	*		10	Dust filter cover	Inspect for traces of dust build up inside cover	-	1
						Inspect for damaged seal and dust leaks across seal	-	1
	O	*		20	Upper cyclone chamber	Clean	-	1
	T	*		4	Engine compartment	Clean	-	1
	O			9	Main brush	Rotate end-for-end	-	1
	T			9	Main brush	Check brush pattern and adjust if needed	-	1
	T			11	Side brush	Check pattern	-	1
	T			17	Propelling motor	Torque shaft nut (after initial 50 hours only)	-	1
	T			3	Rear wheel	Torque wheel nuts (after initial 50 hours only)	-	1
	T			5	Battery	Clean and tighten battery cable connections (after initial 50 hours only)	-	1
	T			19	Wet side brush dust control spray nozzle (option)	Check pattern	-	1
	T			4	Fuel pipes and clamps	Check for tightness and wear	-	All

MAINTENANCE

The table below indicates the *Person Responsible* for each procedure.

O = Operator.

T = Trained Personnel.

 = Indicates unique maintenance schedule for machines equipped with HEPA filtration system.

Interval	Person Resp.	HEPA	Non-HEPA	Key	Description	Procedure	Lube/ Fluid	No. of Service Points	
100 Hours	T			4	Engine	Change oil and filter element	EO	1	
						Check belt tension	-	1	
	T			*	10	Hopper dust filter	Check for damage, clean or replace	-	1
	T			*	10	Upper cyclone chamber	Clean	-	All
	T			*	10	Dust filter cover	Inspect for damaged seal and dust leaks across seal	-	All
	T				10	Cyclone and filter housing	Clean	-	All
	T			*	10	Cyclonic chamber and dust tray flaps	Check for wear, damage, and ensure flaps are fully open and free of debris buildup	-	All
	O				3, 7	Tires	Check for damage	-	3
Check pressure							-	1	
O				13	Main brush and hopper seals	Check for damage or wear	-	All	
200 Hours	T			2	Rear wheel support bearings	Lubricate	SPL	2	
	T			1	Radiator hoses and clamps	Check for tightness and wear	-	2	
	T			14	Brakes	Check and adjust travel	-	1	
	T	*		20	Lower cyclone chamber	Clean	-	All	
	T	*		20	Perma-Filter	Inspect and clean	-	All	
	T			4	Vacuum fan belt	Check tension and wear	-	1	
	T			16	Side brush guard	Rotate 90°	-	1	
	T			8	Hopper lift arm pivots	Lubricate	SPL	2	
	T			16	Side brush pivot(s)	Check adjustment	-	1	
	O			18	Wet side brush dust control filter screens (option)	Clean	-	2	

The table below indicates the *Person Responsible* for each procedure.

O = Operator.

T = Trained Personnel.

 = Indicates unique maintenance schedule for machines equipped with HEPA filtration system.

Interval	Person Resp.	HEPA	Non-HEPA	Key	Description	Procedure	Lube/Fluid	No. of Service Points
400 Hours	T			7	Front wheel bearings	Replace filler cap	–	1
	T	*		20	HEPA filter housing (Option)	Inspect and clean the filter housing	–	1
800 Hours	T			15	Hydraulic fluid reservoir	Replace filler cap	–	1
						Replace suction strainer	–	1
	T			15	Hydraulic fluid filter	Change filter element	–	All
	T			–	Hydraulic hoses	Check for wear and damage	–	All
	T			17	Propelling motor	Torque shaft nut	–	1
	T			3	Rear wheel	Torque wheel nuts	–	1
	T			5	Battery	Clean and tighten battery cable connections	–	1
	T			4	Engine	Replace fuel filter	–	1
		Check valve clearance	–			1		
T			1	Cooling system	Flush	WG	1	
1200 Hours	T			15	Hydraulic fluid filter	* Change filter element	–	All
2400 Hours	T			15	Hydraulic fluid reservoir	* Replace suction strainer	–	1
						* Change hydraulic fluid	HYDO	1

NOTE: Change the hydraulic fluid, filter, and suction strainer, indicated (), after every 800 hours for machines NOT originally equipped with **TennantTrue** premium hydraulic fluid. (See Hydraulics section).*

LUBRICANT/FLUID

EO 10W–30, 10W–40 or 15W–40 Engine oil, API diesel classification CF or better.

HYDO . . **TennantTrue** premium hydraulic fluid or equivalent

SPL . . . Special lubricant, Lubriplate EMB grease (TENNANT part no. 01433–1)

WG . . . Water and ethylene glycol anti-freeze, –34° C (–30° F)

NOTE: More frequent intervals may be required in extremely dusty conditions.

MAINTENANCE

LUBRICATION

FOR SAFETY: Before leaving or servicing machine, stop on level surface, set parking brake, turn off machine, and remove key.

ENGINE OIL

Check the engine oil level daily. Change the oil and oil filter after every 100 hours of operation.

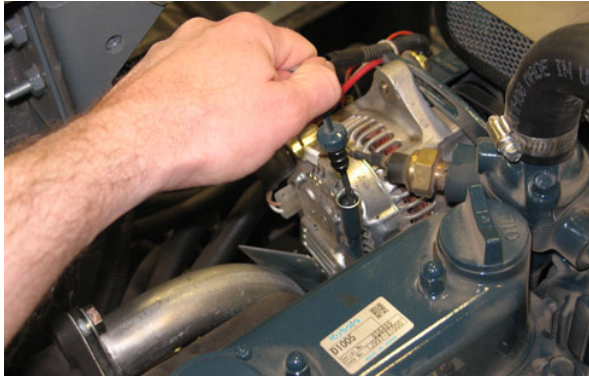

Fill the engine with oil until the oil is between the indicator marks on the dipstick. **DO NOT** fill past the top indicator mark. The engine oil capacity is 5.1 L (5.4 qt) with oil filter.

REAR WHEEL SUPPORT

Lubricate the rear wheel support bearings after every 200 hours of operation.

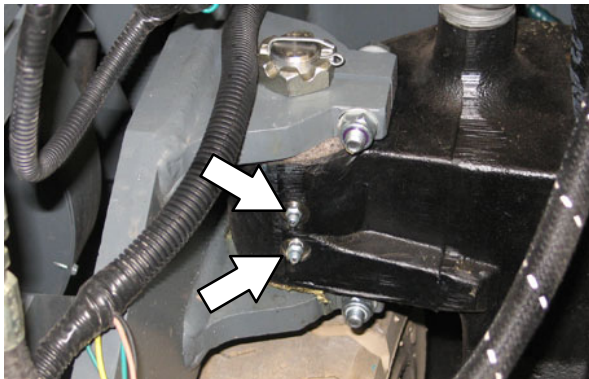

FRONT WHEEL BEARINGS

Repack and adjust the front wheel bearings every 400 hours of operation.

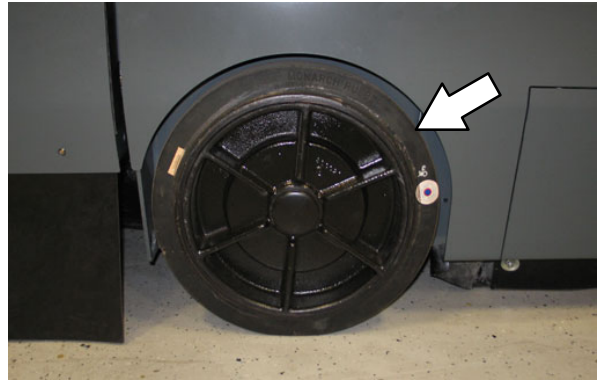

HOPPER LIFT ARM PIVOTS

Lubricate the hopper lift arm bearings after every 200 hours of operation.

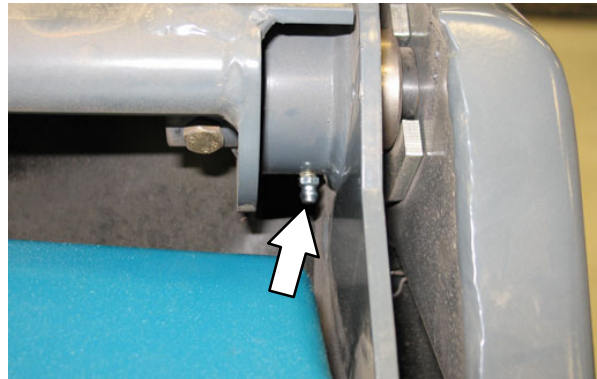

HYDRAULICS

FOR SAFETY: Before leaving or servicing machine, stop on level surface, set parking brake, turn off machine, and remove key.

HYDRAULIC FLUID RESERVOIR

Check the hydraulic fluid level and operating temperature daily. The hopper must be down when checking the hydraulic fluid level.

Machines (S/N 000000–005693) have a filler cap with a fluid level dipstick. The hydraulic fluid level should be between the full and add markings on the dipstick.

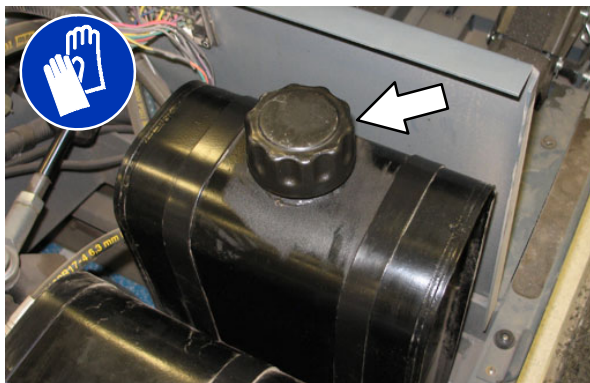

Machines (S/N 005694–) have a fluid level gauge on the hydraulic tank. The hydraulic fluid level should be between the two lines on the hydraulic gauge.

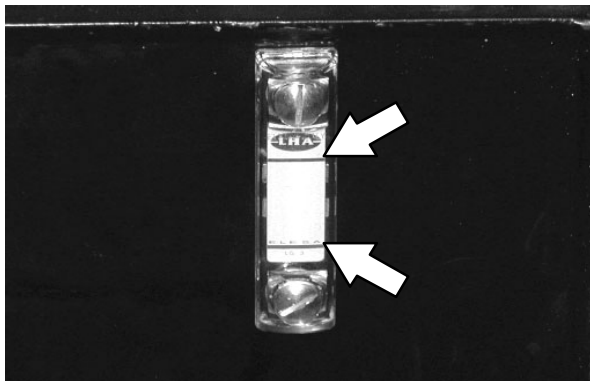

A filler cap is mounted on top of the reservoir. It has a built-in breather and fluid level dipstick. Replace the cap after every 800 hours of operation.

Lubricate the filler cap gasket with a film of hydraulic fluid before putting the cap back on the reservoir.

ATTENTION! Do not overfill the hydraulic fluid reservoir or operate the machine with a low level of hydraulic fluid in the reservoir. Damage to the machine hydraulic system may result.

Drain and refill the hydraulic fluid reservoir with new **TennantTrue** premium hydraulic fluid after every 2400 hours of operation. Machines have a blue colored drop (left photo) on the hydraulic fluid label if originally equipped with **TennantTrue** premium hydraulic fluid.

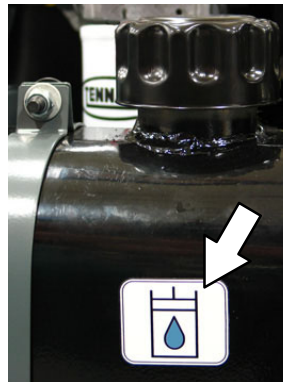

TennantTrue Fluid

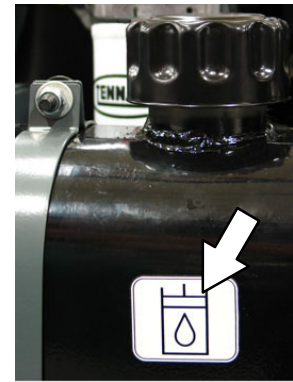

Previous Fluid

NOTE: Change the hydraulic fluid, filter, and suction strainer after every 800 hours for ALL machines that have NOT consistently used **TennantTrue** premium hydraulic fluid or equivalent.

The reservoir has a built-in strainer outlet that filters hydraulic fluid before it enters the system. Replace the strainer after every 2400 hours of operation.

The hydraulic fluid filter is located under the radiator. Replace the filter element after every 1200 hours of operation or if the clogged hydraulic filter light remains on. Check the hydraulic fluid level and refill as needed.

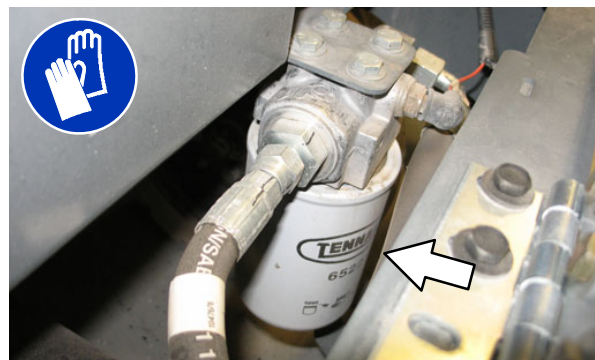

MAINTENANCE

HYDRAULIC FLUID

There are three fluids available for different ambient air temperature ranges:

TennantTrue premium hydraulic fluid (Extended Life)			
Part Number	Capacity	ISO Grade Viscosity Index (VI)	Ambient Air Temperature Ranges
1057710	3.8 L (1 gal)	ISO 100 VI 126 or higher	19° C (65° F) or higher
1057711	19 L (5 gal)		
1069019	3.8 L (1 gal)	ISO 68 VI 155 or higher	7 to 43° C (45 to 110° F)
1069020	19 L (5 gal)		
1057707	3.8 L (1 gal)	ISO 32 VI 163 or higher	16° C (60° F) or lower
1057708	19 L (5 gal)		

If using a locally-available hydraulic fluid, be sure the specifications match the Tennant hydraulic fluid specifications. Substitute fluids can cause premature failure of hydraulic components.

ATTENTION! Hydraulic components depend on system hydraulic fluid for internal lubrication. Malfunctions, accelerated wear, and damage will result if dirt or other contaminants enter the hydraulic system.

HYDRAULIC HOSES

Check the hydraulic hoses after every 800 hours of operation for wear or damage.

FOR SAFETY: When servicing machine, use cardboard to locate leaking hydraulic fluid under pressure.

High pressure fluid escaping from a very small hole can almost be invisible, and can cause injury.

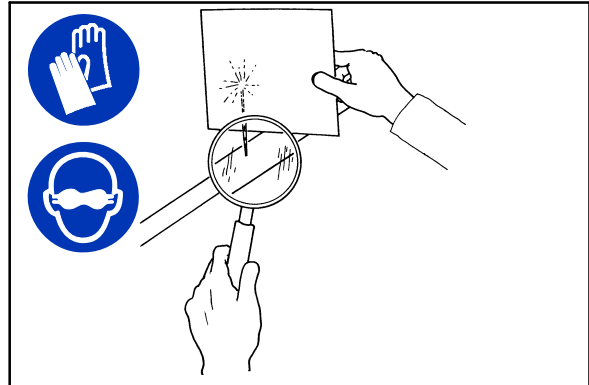

00002

Contact appropriate personnel if a leak is discovered.

ATTENTION: Only use TENNANT supplied hydraulic hoses or equivalent rated hydraulic hoses.

ENGINE

FOR SAFETY: Before leaving or servicing machine, stop on level surface, set parking brake, turn off machine, and remove key.

COOLING SYSTEM

FOR SAFETY: When servicing machine, avoid contact with hot engine coolant. Do not remove cap from radiator when engine is hot. Allow engine to cool.

Check the radiator coolant level daily. Refer to the coolant manufacturer for water/coolant mixing instructions.

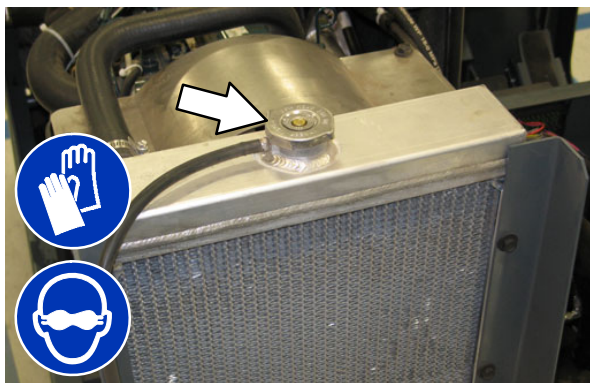

Check the radiator hoses and clamps after every 200 hours of operation. Tighten loose clamps. Replace damaged hoses and clamps.

Check the radiator core exterior and hydraulic cooler fins for debris daily. Blow or rinse (with low pressure air or water) all dust through the grill and radiator fins, the opposite direction of normal air flow. Be careful to not bend the cooling fins when cleaning. Clean thoroughly to prevent the fins from becoming encrusted with dust. To avoid cracking the radiator, allow the radiator and cooler fins to cool before cleaning.

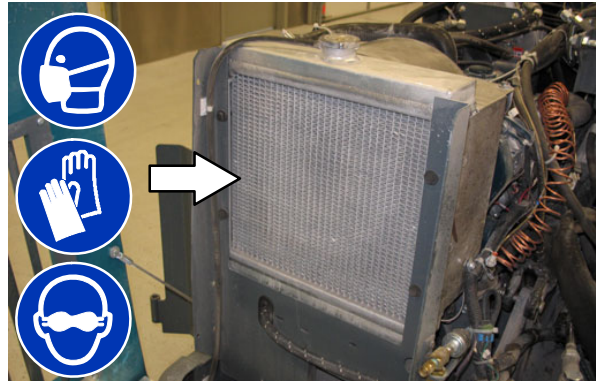

Flush the radiator and the cooling system after every 800 hours of operation.

CLEAN THE ENGINE AND ENGINE COMPARTMENT

Clean the engine and engine compartment after every 50 hours of operation on machines equipped with HEPA.

FOR SAFETY: When servicing machine, avoid contact with hot engine coolant. Do not remove cap from radiator when engine is hot. Allow engine to cool.

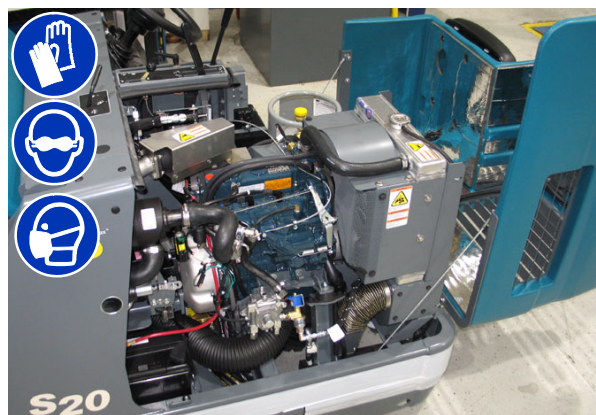

MAINTENANCE

AIR FILTER INDICATOR

Check the indicator daily. The indicator red line will move as the air filter element fills with dirt. Do not replace the air filter element until the red line reaches 5 kPa (20 in H₂O) and the "SERVICE WHEN RED" window is filled with red. The engine must be running to get an accurate air indicator reading.

FOR SAFETY: When servicing machine, avoid moving parts. Do not wear loose clothing or jewelry.



AIR FILTER

FOR SAFETY: Before leaving or servicing machine, stop on level surface, set parking brake, turn off machine, and remove key.

The engine air filter housing is located in front of the engine compartment under the lintel.

Replace the air filter element when the air filter indicator shows restriction in the air intake system or the filter element is damaged. Refer to *AIR FILTER INDICATOR*.

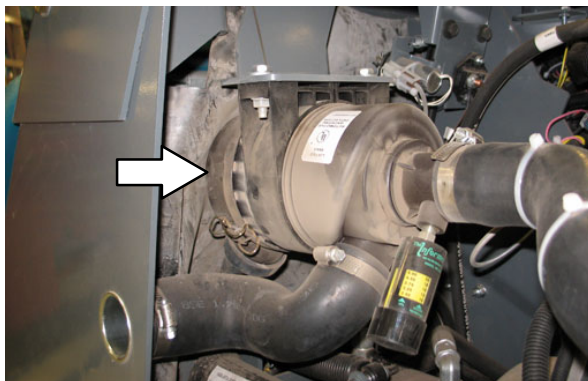

To remove the filter element, raise the hopper and engage the hopper support bar. Set the parking brake and turn the engine off. Remove the top two dust skirt clips and pull back the dust skirt to access the air filter housing.



WARNING: Raised hopper may fall. Engage hopper support bar.

Remove the filter element. Carefully clean the end cap and the interior of the housing with a damp cloth. Clean the housing sealing surfaces.



Install the filter element into the air filter housing and reinstall the dust cap with the water drain pointing down.

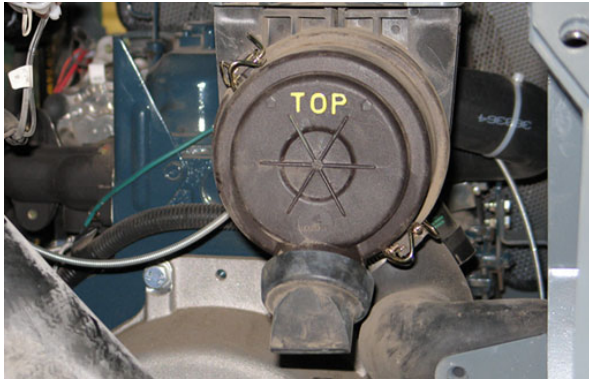

Push the reset button on the end of the indicator to reset the air filter indicator after replacing the air filter element.

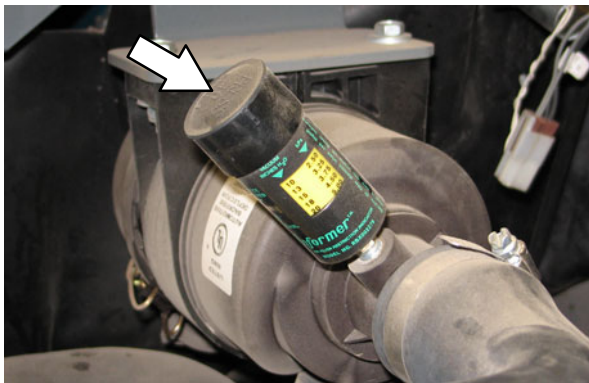

ENGINE BELT

Check the engine belt tension after every 100 hours of operation. Adjust tension as necessary. Proper belt tension is 12 mm (0.5 in) from a force of 4.5 kg (10 lb) applied at the mid-point of the longest span.

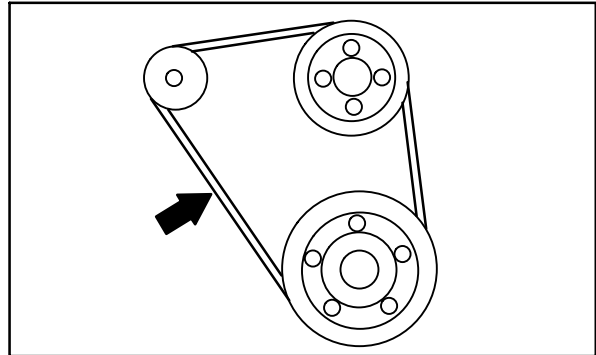

08935

! WARNING: Moving belt and fan. Keep away.

VALVE CLEARANCE

Check and adjust the valve clearance to 0.145 to 0.185 mm (0.0057 to 0.0072 in) while the engine is cold after every 800 hours of operation.

FUEL FILTER

The fuel filter traps fuel contaminants. The filter is located on the fuel line near the fuel pump.

FOR SAFETY: When servicing machine, keep flames and sparks away from fuel system service area. Keep area well ventilated.

Replace the fuel filter after every 800 hours of operation.

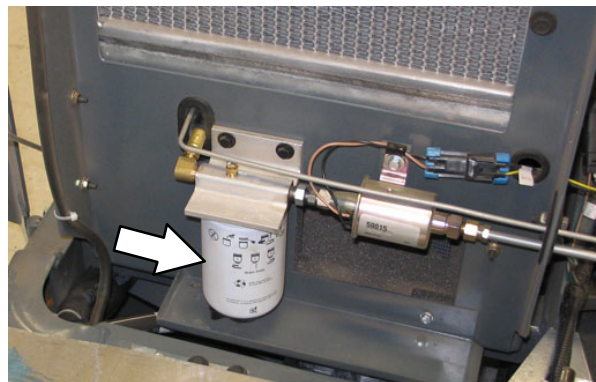

MAINTENANCE

FUEL LINES

Check the fuel lines every 50 hours of operation. If the clamp band is loose, apply oil to the screw of the band and securely tighten the band.

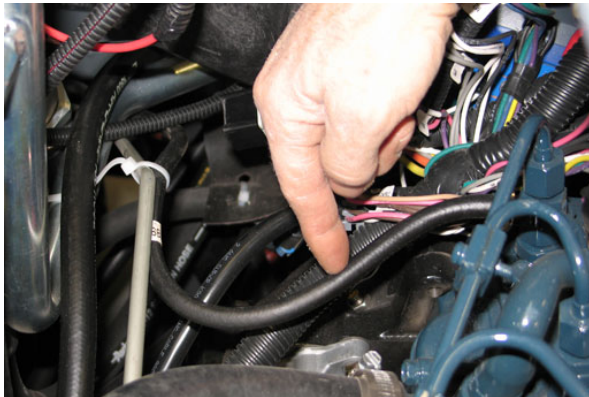

The rubber fuel lines can become worn—out whether the engine has been used much or not. Replace the fuel lines and clamp bands every two years.

FOR SAFETY: When servicing machine, keep flames and sparks away from fuel system service area. Keep area well ventilated.

If the fuel lines and clamp bands are found worn or damaged before two years' time; replace or repair them at once. Bleed the fuel system after replacement of any fuel lines, see PRIMING THE FUEL SYSTEM. When the fuel lines are not installed, plug both ends with clean cloth or paper to prevent dirt from entering the lines. Dirt in the lines can cause fuel injection pump malfunction.

PRIMING THE FUEL SYSTEM

Typical diesel fuel systems require priming to remove pockets of air from the fuel lines and fuel components. This is usually required after running out of fuel, changing fuel filter elements or repairing a fuel system component. Air in the fuel prevents smooth engine operation.

This fuel system however is self-priming. The return line comes from the top of the injector that allows the air to escape through the return line.

VACUUM FAN BELT

Check the vacuum fan belt tension and wear after every 200 hours of operation. The correct tension is when the belt deflects 4 mm (0.16 in) from a force of 0.7 kg (1.5 lb) at belt midpoint.

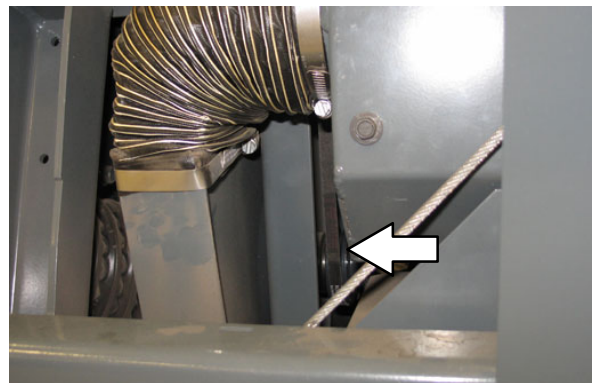

BATTERY

Clean and tighten the battery connections after the first 50 hours of operation and after every 800 hours after that. Do not remove the vent plugs from the battery or add water to the battery.



FOR SAFETY: When servicing machine, avoid contact with battery acid.

FUSES AND RELAYS

RELAY PANEL FUSES AND RELAYS

Remove the relay panel cover to access fuses and relays. Always replace a fuse with a fuse of the same amperage.

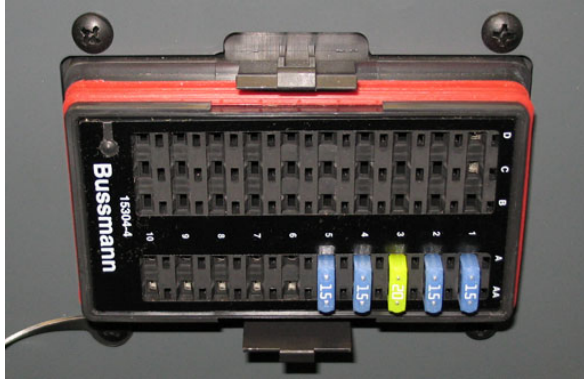

Refer to the diagram below for locations of the *fuses* and *relays* on the relay panel.

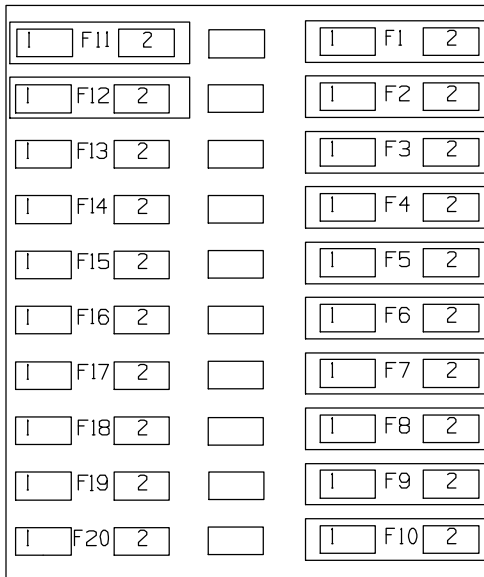

Refer to the table below for the *fuses* and circuits protected.

Fuse	Rating	Circuit Protected
FU1	15 A	Thermo-Sentry
FU2	15 A	Engine, Instrumentation
FU3	20 A	Shaker, Instrumentation
FU4	15 A	Lights
FU5	15 A	Horn
FU6	5 A	Windshield Wiper (Optional)
FU7	15 A	Turn Signals (Optional)
FU8	15A	Wet Side Brush Dust Control (Optional)
FU9	5A	Cab Fan (Optional)
FU10	15 A	Extra
FU11	15 A	Telemetry
FU12	30A	Glow Plugs
FU13	-	Not Used
FU14	-	Not Used
FU15	-	Not Used
FU16	-	Not Used
FU17	-	Not Used
FU18	-	Not Used
FU19	-	Not Used
FU20	-	Not Used

NOTE: Always replace a fuse with a fuse of the same amperage.

Refer to the table below for the *relays* and circuits controlled.

Relay	Rating	Circuit Controlled
M1	12 VDC, 40 A	Starter
M2	12 VDC, 40 A	Thermo-Sentry
M3	12 VDC, 40 A	Engine / Fuel Pump

HEPA (HIGH EFFICIENCY PARTICULATE ARRESTANCE) FILTRATION SYSTEM (OPTION)

The High Efficiency Particulate Arrestance (HEPA) filtration system is a dry sweeping system consisting of the dry dust control, cyclone chamber, and HEPA filter box. The filters, skirts and seals in each of these areas are critical in the performance of the HEPA system.

The optional HEPA filtration system helps clean in fine dust environments.

NOTE: While cleaning or performing any type of maintenance on HEPA filter systems, refer to company or local regulations regarding safety requirements.

HOPPER

Inspect and clean the hopper daily.

1. Turn on the machine, raise the hopper approximately 3–4 in. (76.2–101.6 mm), open hopper dump door, and turn off the machine.



WARNING: Lift arm pinch point. Stay clear of hopper lift arms.

2. Open the hopper access door.

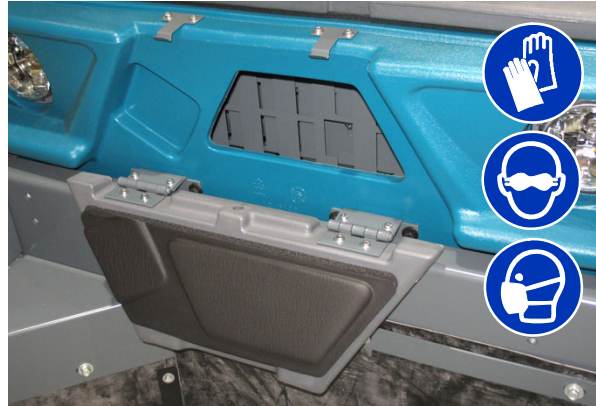

3. Clean any debris from hopper.
4. HEPA Machines: Use a garden hose to clean the hopper out through the hopper access door.
5. Close and secure the hopper access door.
6. Close and secure the hopper cover.
7. Turn on the machine and lower the hopper.
8. Allow hopper to fully dry before using machine.

HOPPER DUST FILTER

FOR SAFETY: Before leaving or servicing machine, stop on level surface, set parking brake, turn off machine, and remove key.

REPLACING THE HOPPER DUST FILTER

Inspect and clean the hopper dust filter and filter cover after every 100 hours of machine operation or 50 hours on machines equipped with HEPA. Replace damaged dust filters.

NOTE: Clean the filter more often if used in extremely dusty conditions.

1. Press the filter shaker button to shake dust and debris from the primary dust filter.
2. Unlatch and open the hopper cover. Support the hopper cover open with the hopper cover prop rod.

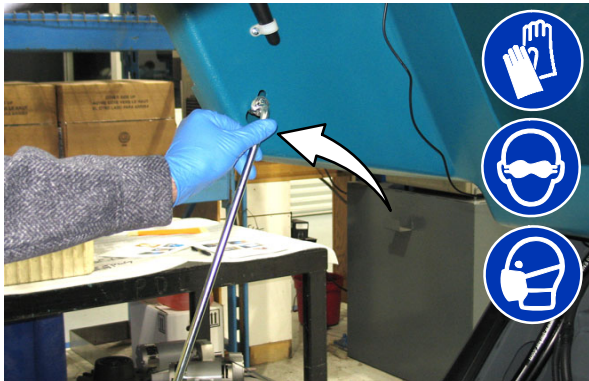

3. Completely loosen the two wing nuts securing the dust filter cover to the upper cyclone chamber.
4. Non-HEPA Machines: Remove the dust filter cover.

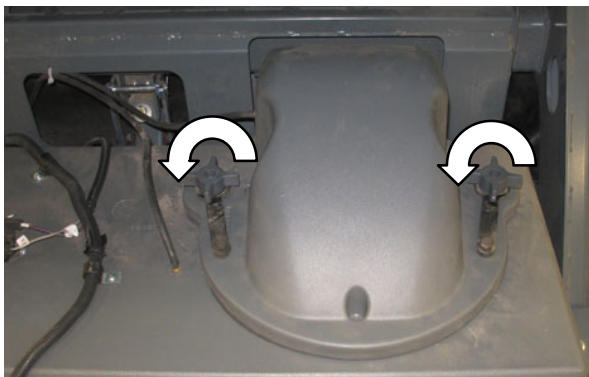

5. HEPA Machines: Remove the HEPA filter assembly.

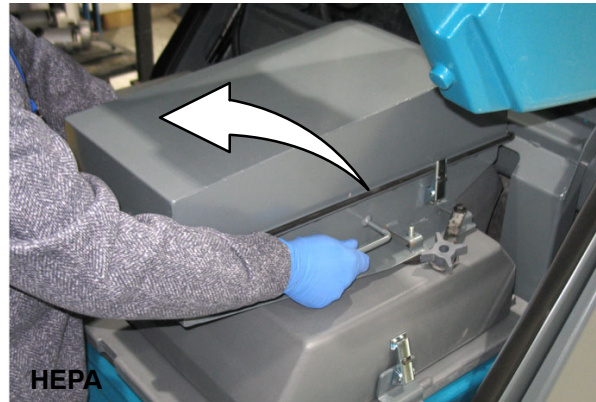

6. HEPA Machines: Clean and inspect the HEPA filter assembly seal for wear and damage. Replace the seal if it is worn or damaged.

NOTE: If dust is detected on the inside of the cover, check filter seal height

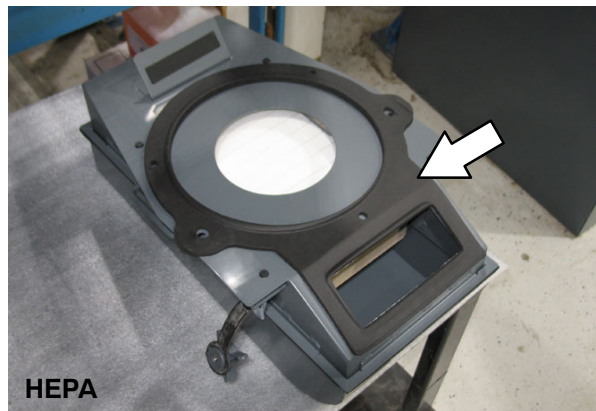

MAINTENANCE

- Use both hands to firmly grasp the dust filter and carefully lift the dust filter from the dust filter compartment. **DO NOT** use the seal to lift the dust filter from the dust filter compartment.



- Clean or discard the dust filter element. Refer to *CLEANING THE DUST FILTER*.
- Clean the upper cyclone chamber. Refer to *CLEANING THE UPPER CYCLONE CHAMBER*.
- Reinstall the dust filter.
- Reinstall the dust filter cover or HEPA filter assembly.
- Close the hopper cover.

CHECK DUST FILTER SEAL HEIGHT

If excessive dust occurs while sweeping, check the dust filter seal height. The distance from the shaker bracket to the top of the compartment should be 8.125 in. (206.375 mm). Adjust if necessary.

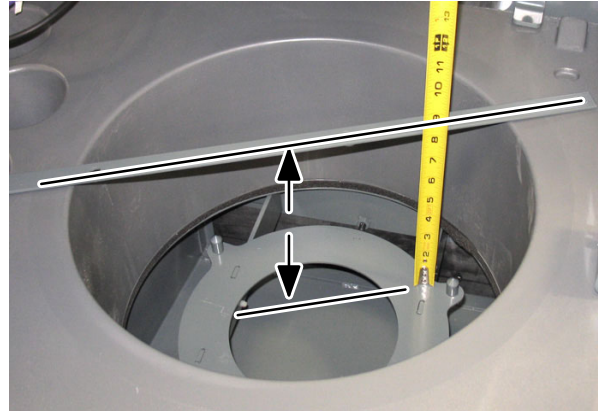

CLEANING THE DUST FILTER

MACHINES WITH STANDARD FILTRATION SYSTEM

Use one of the following methods to clean the dust filter:

SHAKING–Press the *filter shaker switch*.

TAPPING–Tap the filter gently on a flat surface. **Do not damage the edges of the filter.** The filter will not seal properly if the edges of the filter are damaged.

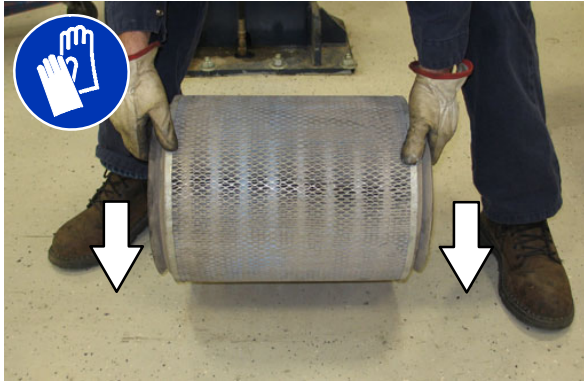

AIR–Always wear eye protection when using compressed air. Blow air through the center of the filter and out toward the exterior. Never use more than 550 kPa (80 psi) of air pressure with a nozzle no smaller than 3 mm (0.13 in) and never hold the nozzle closer than 50 mm (2 in) to the filter.



MACHINES EQUIPPED WITH HEPA FILTRATION SYSTEM

Use one of the following methods to clean the dust filter on machines equipped with HEPA.

SHAKING–Press the *filter shaker switch*.

TAPPING–Place the filter into a plastic bag and gently tap the filter gently on a flat surface. **Do not damage the edges of the filter.** The filter will not seal properly if the edges of the filter are damaged.



DO NOT use air to clean the dust filter.



Inspect the dust filter seals for proper seal and damage. Dust build up on the seal surfaces means dust is getting past the dust filter, significantly reducing the HEPA filter life.

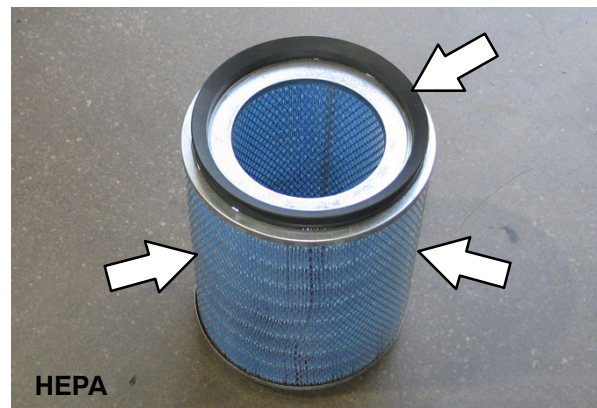

CLEANING THE CYCLONE ASSEMBLY

CLEANING THE UPPER CYCLONE CHAMBER

Clean the upper cyclone chamber and filter housing every 100 hours of machine operation or 50 hours on machines equipped with HEPA.

FOR SAFETY: Before leaving or servicing machine, stop on level surface, set parking brake, turn off machine, and remove key.

1. Clean dust and debris from the dust filter housing.

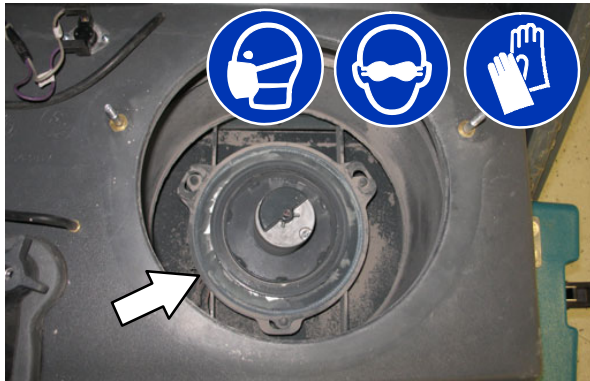

2. Machines (S/N 006266-), open the front clean out door on the upper cyclone chamber and clean.



3. HEPA Machines: Use a HEPA certified vacuum to clean dust and debris from the interior of the upper cyclone chamber.

NOTE: A HEPA certified vacuum is recommended to clean the HEPA filter system. Refer to company or local regulations regarding safety requirements.

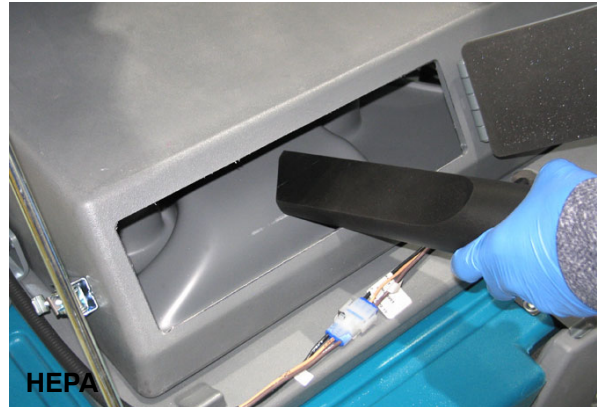

4. HEPA Machines: Use a HEPA certified vacuum to clean the slots located at the top of the dust filter compartment.

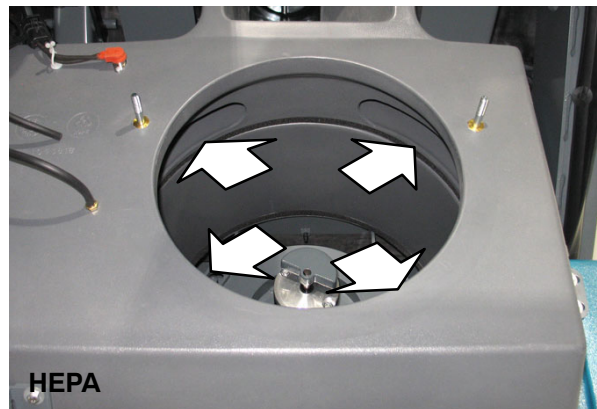

5. Close and secure the upper cyclone chamber access door when finished cleaning the interior of the upper cyclone chamber.

CLEANING THE LOWER CYCLONE CHAMBER

Clean the cyclones after every 100 hours of operation.

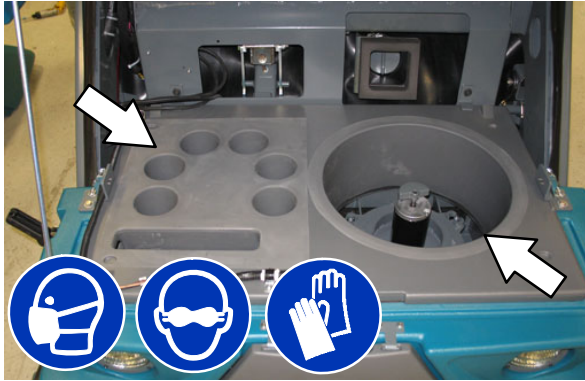

2. Disconnect the main wire harness from the filter shaker assembly and remove the filter shaker assembly from the filter compartment.

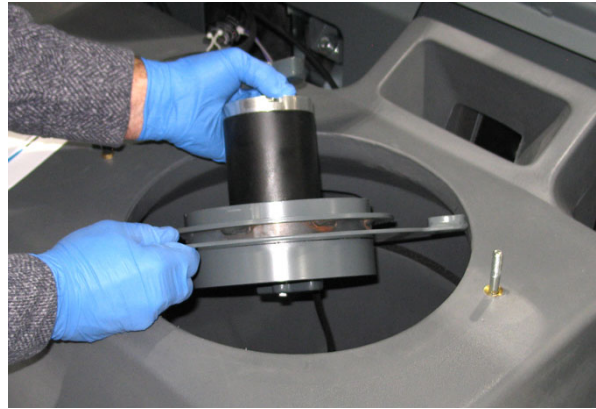
**CLEANING THE LOWER CYCLONE CHAMBER (HEPA OPTION)**

Machines equipped with HEPA require additional cleaning of the lower cyclone chamber and Perma-Filter. Clean the lower cyclone chamber and Perma-Filter every 200 hours of operation.

1. Disconnect the vacuum hose from the upper cyclone chamber.

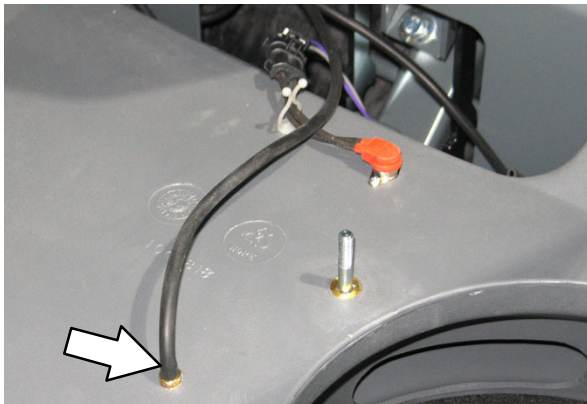

3. Disconnect the main wire harness from the cyclone chamber temperature switch.



MAINTENANCE

4. Loosen clamps securing the upper cyclone chamber to hopper and remove the upper cyclone chamber from the hopper.

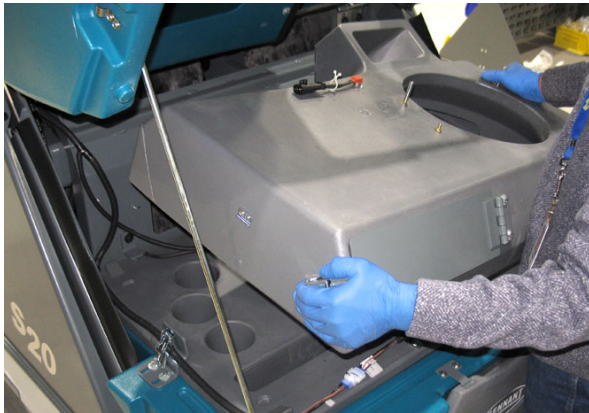

5. Inspect and clean the upper cyclone chamber seal. Replace seals if they are damaged or worn.

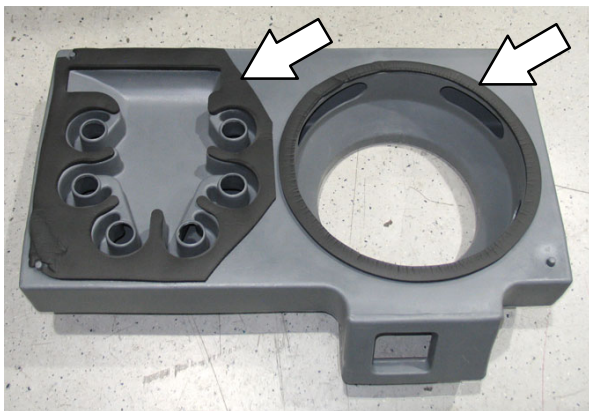

6. Inspect and clean the filter chamber inlet seal. Replace seal if they are damaged or worn.



7. Disconnect the main wire harness from the lower cyclone chamber harness.



8. Remove the hardware securing the main wire harness to the lower cyclone chamber.



9. Remove the four brackets securing the lower cyclone chamber to the hopper.

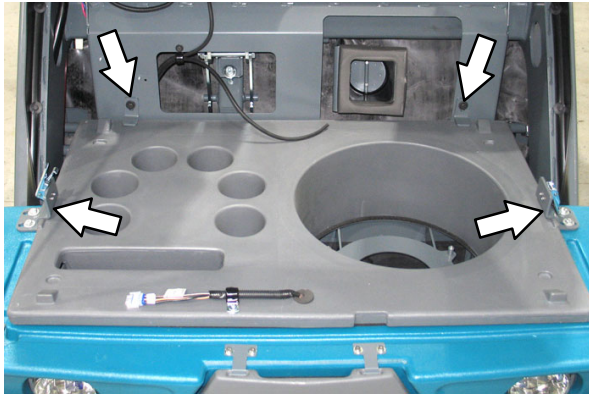

10. With the help of an assistant, lift the lower cyclone chamber and remove it from the hopper.

11. Turn on the machine, raise the hopper approximately 3–4 in. (76.2–101.6 mm), open hopper dump door, and turn off the machine.

12. Open the hopper access door.



13. Clean all dirt and debris from the hopper.

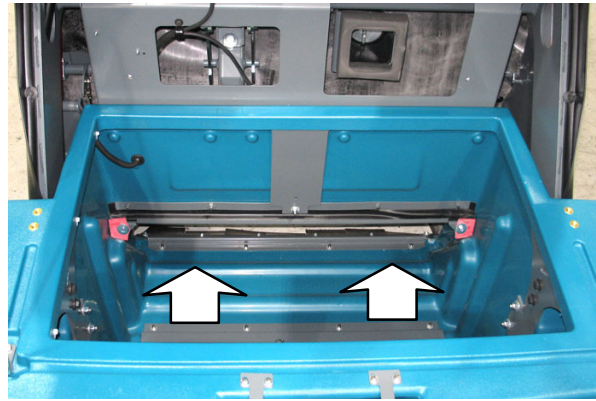

14. Use a garden hose to clean out the filter compartment and lower cyclone compartment.

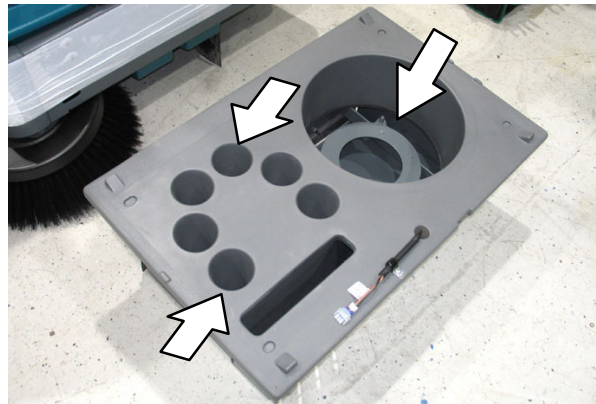

15. Inspect cyclone Perma-Filter inside the lower cyclone compartment for debris.

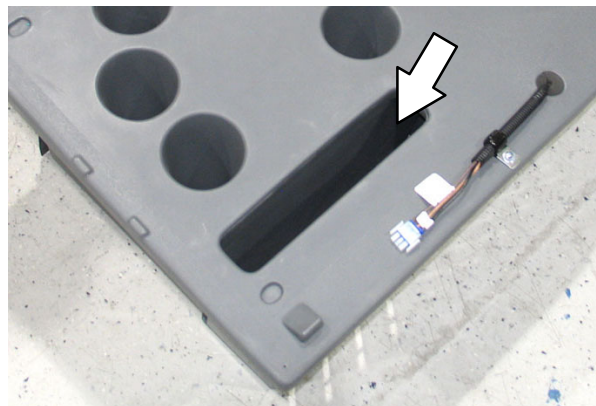

16. Clean the cyclone Perma-Filter using a garden hose.

MAINTENANCE

17. Inspect the lower cyclone chamber flaps and ensure they open and close completely. Remove any excessive dust buildup on the flaps.

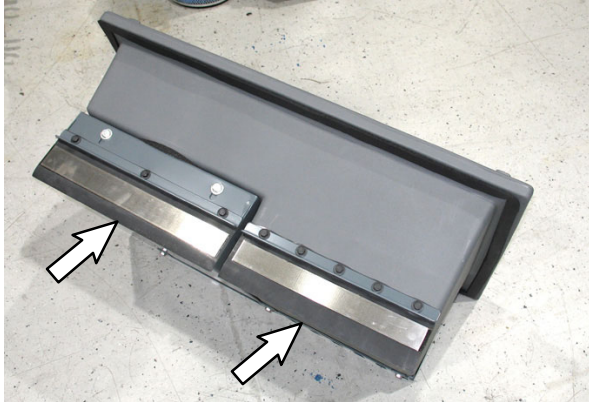

18. Allow the lower cyclone compartment / dust filter compartment / Perma-Filter compartment to completely dry.
19. Turn on the machine, lower the hopper, and turn off the machine.
20. With the help of an assistant, reinstall the lower cyclone chamber into the hopper. Ensure no hoses or harness leads are pinched between the bottom of the lower cyclone chamber and the top of the hopper.
21. Reinstall the four brackets to secure the lower cyclone chamber to the hopper.
22. Secure the main wire harness to the lower cyclone chamber and reconnect the main wire harness to the lower cyclone chamber harness.

NOTE: Be sure the main wire harness is routed to the outside of the bracket. The upper cyclone chamber will not seat properly if harness is routed to the inside.

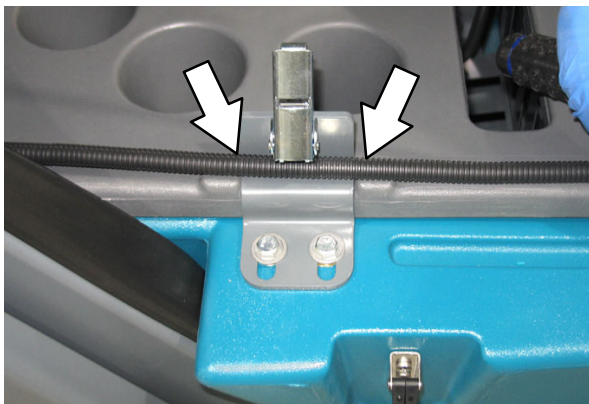

23. Reinstall the upper cyclone assembly, dust filter, and HEPA filter assembly in reverse order of disassembly.

CYCLONE PERMA-FILTER

Clean heavy or wet dust and excess debris from the cyclone Perma-Filter as necessary. Check the cyclone Perma-Filter for damage every 100 hours of operation.



INSPECT AND CLEAN THE HEPA FILTER HOUSING (OPTION)

Inspect and clean the HEPA filter housing after every 400 hours of machine operation. Replace the HEPA filter if it is plugged and / or damaged.

1. Unlatch and open the hopper cover. Support the hopper cover open with the hopper cover prop rod.

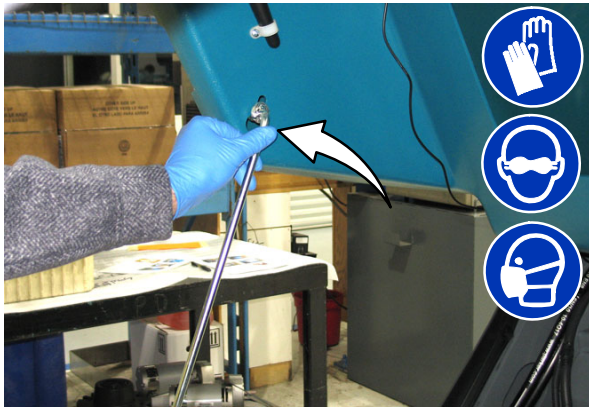

2. Loosen the three clamps securing the cover to the HEPA filter assembly and remove the cover.

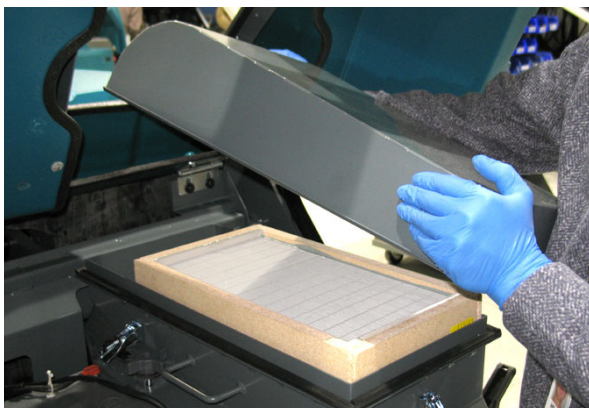

3. Remove the HEPA filter from the HEPA filter compartment.



4. Inspect the HEPA filter and seals for dust, debris, and damage. Replace the HEPA filter if filter or filter seals are damaged.

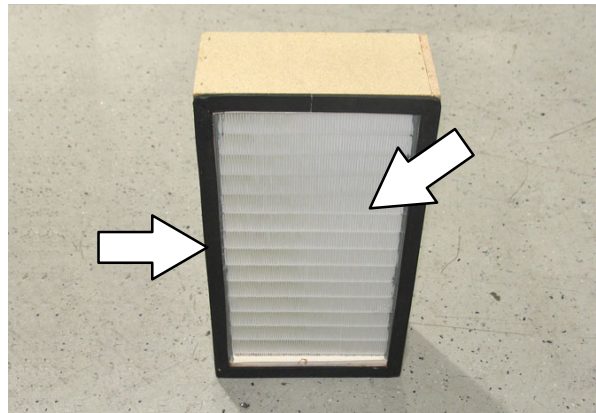

5. Use a HEPA certified vacuum to clean the HEPA filter compartment and the HEPA filter housing inlet hose.

NOTE: A HEPA certified vacuum is recommended to clean the HEPA filter system. Refer to company or local regulations regarding safety requirements.

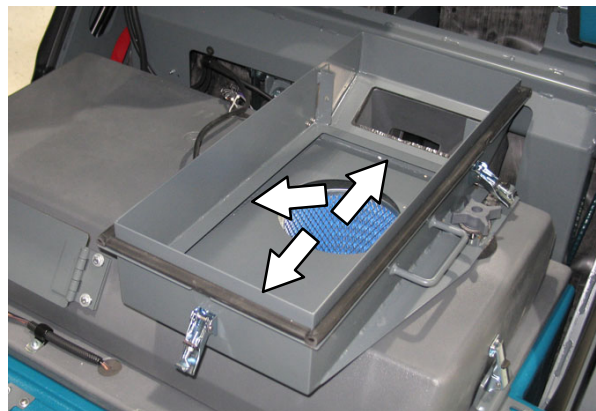

MAINTENANCE

6. Reinstall the HEPA filter into the HEPA filter assembly. Be sure the arrow on the HEPA filter label is pointing up.



7. Reinstall the cover onto the HEPA filter assembly. Ensure all three clamps are completely reinstalled and hold the cover firmly onto the HEPA filter assembly.

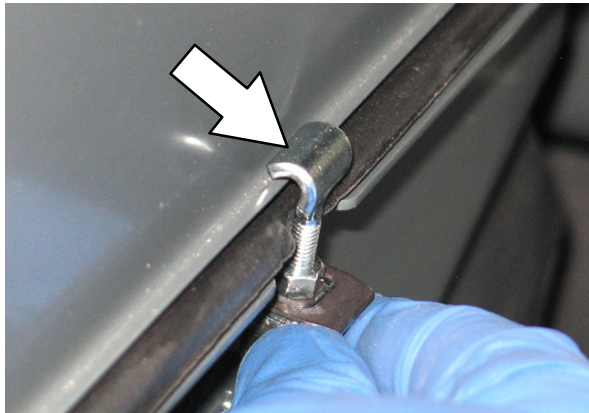

MAIN BRUSH

FOR SAFETY: Before leaving or servicing machine, stop on level surface, set parking brake, turn off machine, and remove key.

Check the brush daily for wear or damage. Remove any string or wire tangled on the main brush, main brush drive hub, or main brush idler hub.



Check the main brush pattern and rotate the brush end-for-end after every 50 hours of operation, for maximum brush life and best sweeping performance. Refer to *REPLACING OR ROTATING THE MAIN BRUSH*.

Replace the brush when it no longer cleans effectively.

REPLACING OR ROTATING THE MAIN BRUSH

1. Raise the brush head.

FOR SAFETY: Before leaving or servicing machine, stop on level surface, set parking brake, turn off machine, and remove key.

2. Open the right side main brush access door.
3. Loosen the brush idler plate T-bolt. Remove the brush idler arm assembly.

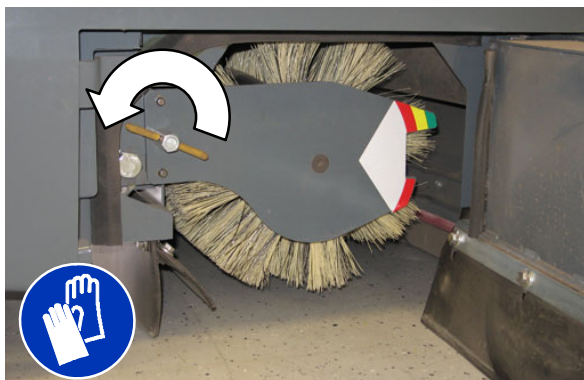

4. Pull the main brush from the main brush compartment.



5. Replace or rotate the main brush end-for-end.
6. Slide the brush into the brush compartment and all the way onto the drive plug.
7. Reinstall the brush idler plate.

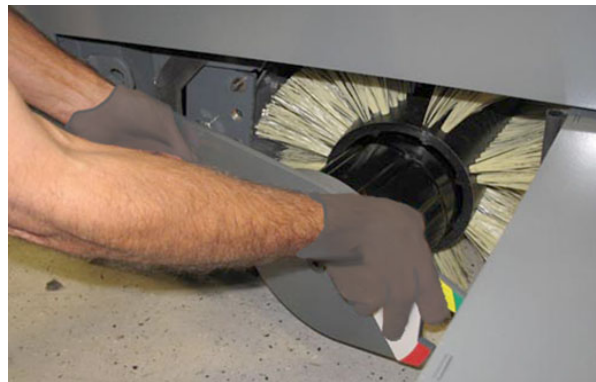

8. Close the main brush access door.
9. Check and adjust the brush pattern if needed. Refer to *CHECKING THE MAIN BRUSH PATTERN*.

MAINTENANCE

CHECKING THE MAIN BRUSH PATTERN

1. Apply chalk, or a similar marking material, to a smooth and level section of the floor.

NOTE: If chalk or other material is not available, allow the brush to spin on the floor for two minutes. A polish mark will remain on the floor.

2. Lower the main brush onto the chalked area and hold it there for 15 to 20 seconds without moving the machine.
3. Raise the brush and drive the machine from the chalked area. The brush pattern should be 50 to 75 mm (2.0 to 3.0 in) across the entire length of the brush. Refer to *ADJUSTING THE MAIN BRUSH WIDTH*.

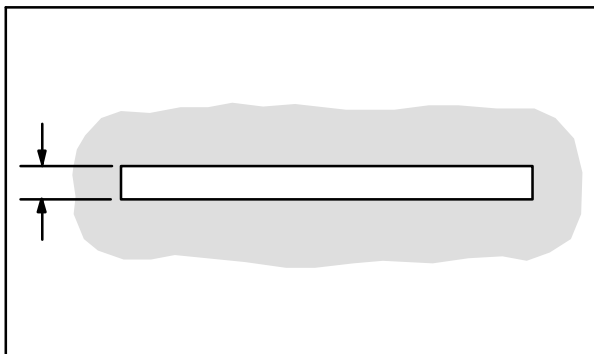

00582

FOR SAFETY: Before leaving or servicing machine, stop on level surface, set parking brake, turn off machine, and remove key.

4. If the brush pattern is tapered, see *ADJUSTING THE MAIN BRUSH TAPER* section of this manual.

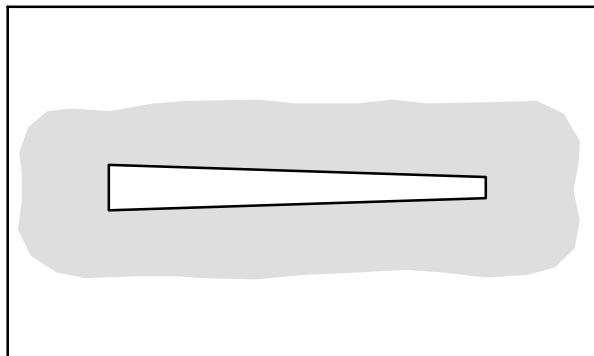

00601

ADJUSTING THE MAIN BRUSH TAPER

FOR SAFETY: Before leaving or servicing machine, stop on level surface, set parking brake, turn off machine, and remove key.

1. Remove the brush idler plate and brush.
2. Loosen the shaft bearing bracket mounting bolts.

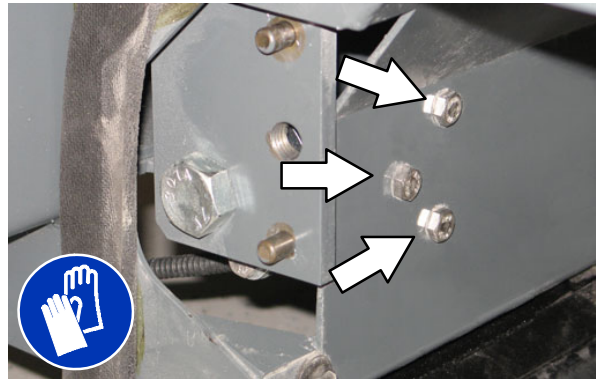

3. Move the bracket up or down in the slots and tighten the mounting bolts.
4. Reinstall the brush and brush idler plate.
5. Check the main brush pattern and readjust as necessary. Maximum taper is 13 mm (0.5 in). Set the main brush adjustment knob to the same color band as the brush idler plate.

ADJUSTING THE MAIN BRUSH WIDTH

FOR SAFETY: Before leaving or servicing machine, stop on level surface, set parking brake, turn off machine, and remove key.

1. Compare the length of the main brush bristles with the color band on the brush idler plate.



2. Loosen the main brush adjustment knob and slide the knob so it matches the color band on the brush idler plate. Retighten the knob.

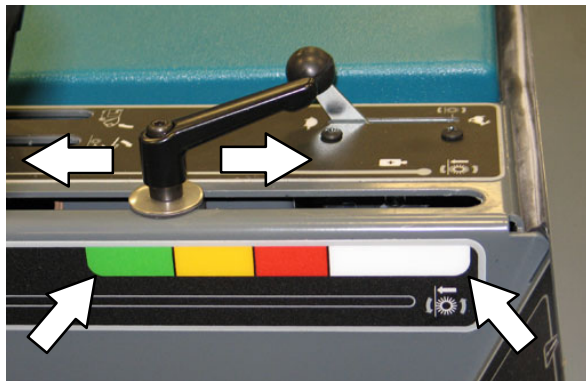

3. Recheck the pattern. Readjust if necessary.

SIDE BRUSH(ES)

Check the brush(es) daily for wear or damage. Remove any string or wire found tangled in the brush(es) or drive hub(s).

Replace the brush(es) when it no longer cleans effectively.

REPLACING THE SIDE BRUSH

1. Stop the machine, set the parking brake and turn the engine off.

FOR SAFETY: Before leaving or servicing machine, stop on level surface, set parking brake, turn off machine, and remove key.

2. Remove the side brush retaining pin from the side brush drive shaft by pulling the pin keeper off over the end of the pin.

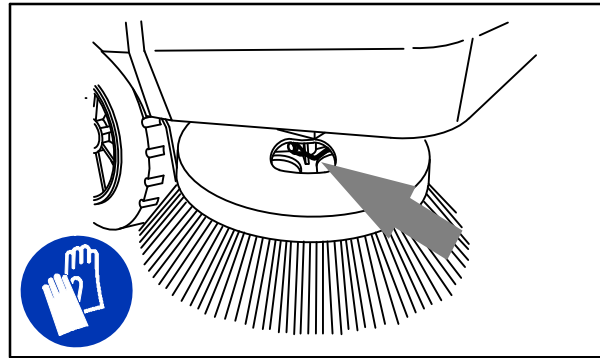

08019

3. Slide the side brush off the side brush drive shaft.

NOTE: Remove the drive hub and put it on the new brush if one is not installed.

4. Slide the new side brush onto the side brush drive shaft.
5. Insert the side brush retaining pin through the side brush hub and shaft.
6. Secure the pin by clipping the pin keeper over the end of the pin.
7. Adjust the side brush pattern with the side brush down pressure knob.

MAINTENANCE

ADJUSTING THE SIDE BRUSH PATTERN

Check the side brush pattern after every 50 hours of operation. The side brush bristles should touch the floor in the patterns shown in the illustration.

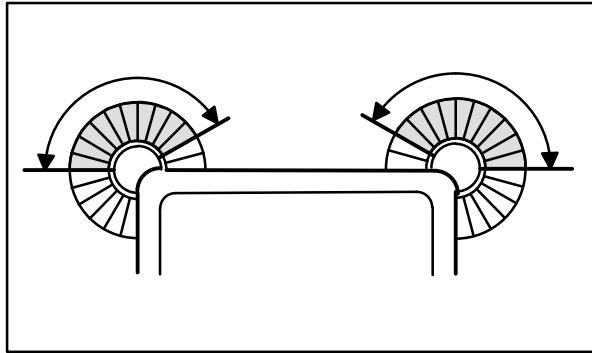

Turn the knob(s) counterclockwise to increase the brush pressure and clockwise to decrease the brush pressure.



SIDE BRUSH GUARD

Rotate the side brush guard 90° after every 200 hours of operation, or sooner if worn. Replace the brush guard after using all four sides.



SIDE BRUSH PIVOT

The side brush pivot should be checked for excessive movement after every 200 hours of operation.

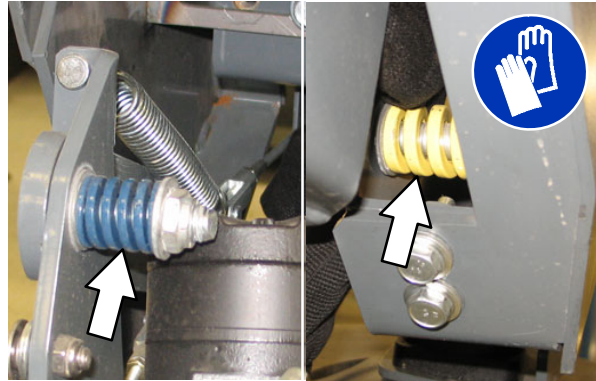

The side brush side tilt (left to right) is adjusted with the two bolts.

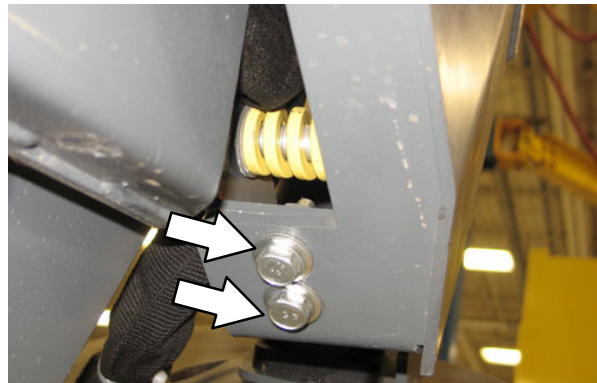

The side brush front to rear tilt is adjusted with the side brush cable and clevis pin.

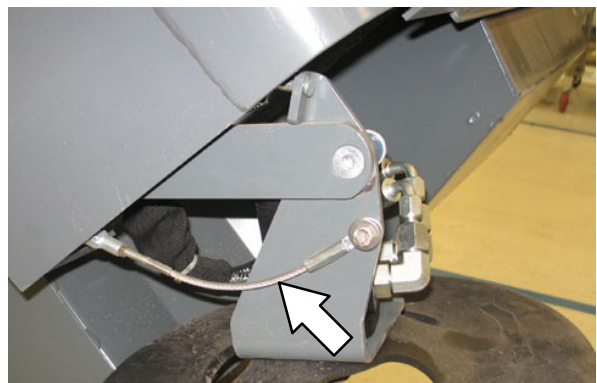

SKIRTS, FLAPS, AND SEALS

FOR SAFETY: Before leaving or servicing machine, stop on level surface, set parking brake, turn off machine, and remove key.

HOPPER LIP SKIRT

The hopper lip skirt is located on the bottom rear of the hopper. The skirt floats over debris and helps deflect that debris into the hopper.

Check the hopper lip skirt for wear or damage daily.

Replace the hopper lip skirt when it no longer touches the floor.

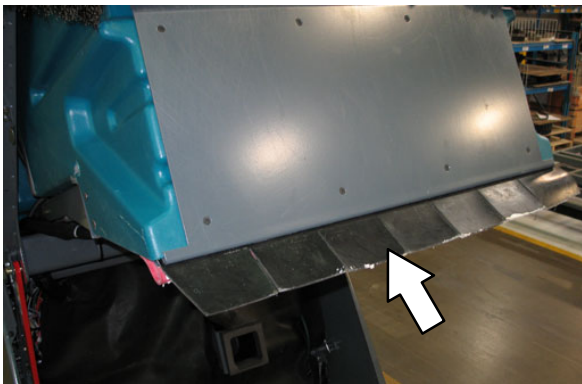

HOPPER SIDE SKIRT

The hopper side skirt is located on the left side of the hopper. The hopper side skirt should clear the floor by 3 mm (0.12 in).

Check the hopper side skirt for wear or damage and adjustment daily.

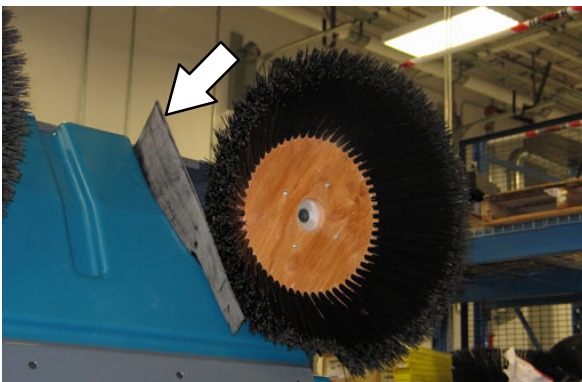

BRUSH DOOR SKIRTS

The brush door skirts are located on the bottom of each of the two main brush doors. The skirt should clear the floor by 3 mm (0.12 in).

Check the skirts for wear or damage and adjustment daily.

NOTE: The brush door skirts have slotted holes to allow for a ground clearance adjustment. Adjust the skirt height with the door closed.

NOTE: Rear tire pressure will affect skirt clearances.

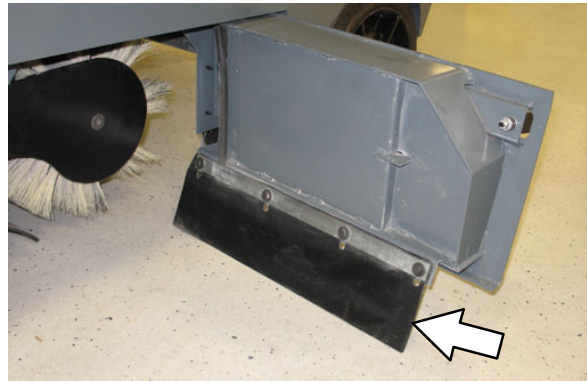

REAR SKIRTS

The two rear skirts are located on the bottom rear of the main brush compartment. The vertical skirt should clear the floor up to 3 mm (0.12 in). The recirculation skirt requires no adjustment.

Check the skirts for wear or damage and adjustment daily.

NOTE: Rear tire pressure will affect skirt clearances.

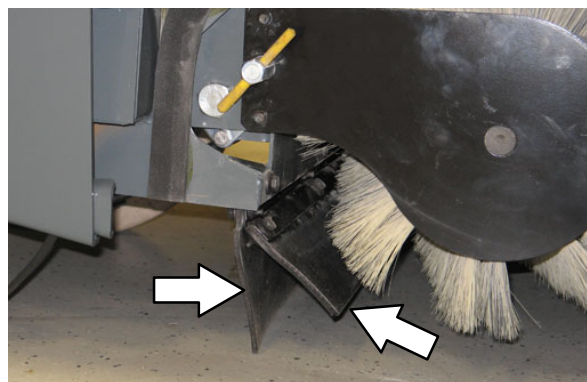

MAINTENANCE

SIDE BRUSH DUST CONTROL SKIRTS (OPTION)

The side brush dust control skirts wrap around the side brush and the front bumper.

Check the side brush dust control skirts for wear or damage daily.



BRUSH DOOR SEALS

The brush door seals are located on both main brush doors and on corresponding portions of the main frame.

Check the seals for wear or damage after every 100 hours of operation.

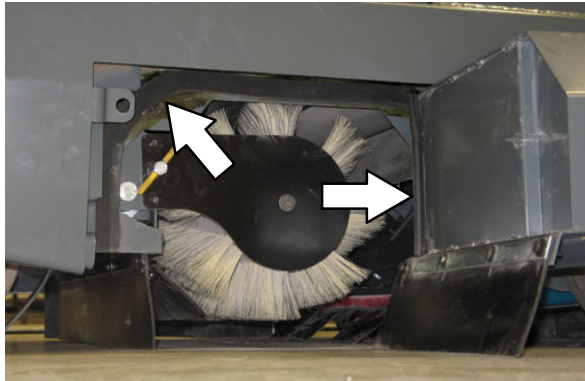

HOPPER SEALS

The hopper seals are located on the top and side portions of the hopper.

Check the seals for wear or damage after every 100 hours of operation.

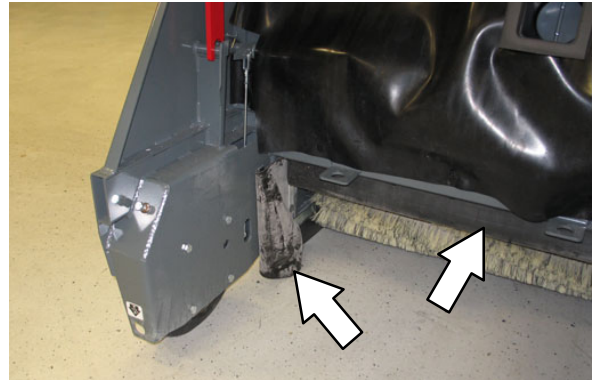

HOPPER ACCESS DOOR SEAL

The hopper access door seal is located on the hopper and seals the front of the debris hopper.

Check the seal for wear or damage after every 100 hours of operation.

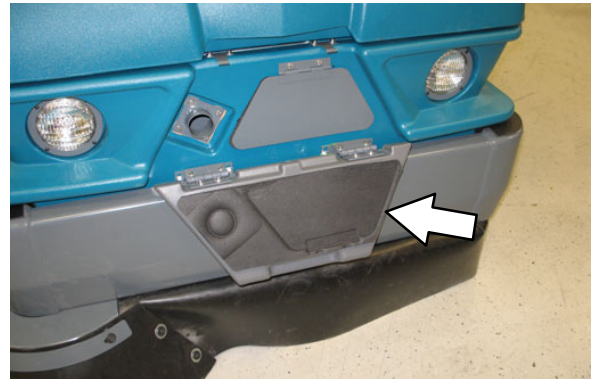

**INNER HOPPER ACCESS DOOR SEAL
(OPTION – VACUUM WAND ONLY)**

The inner hopper access door seal is located on the hopper and seals the front of the debris hopper.

Check the seal for wear or damage after every 100 hours of operation.

**HOPPER DOOR SEALS**

The hopper door seals are located on the hopper door. They seal the hopper when the hopper door is closed.

Check the seals for wear or damage after every 100 hours of operation.

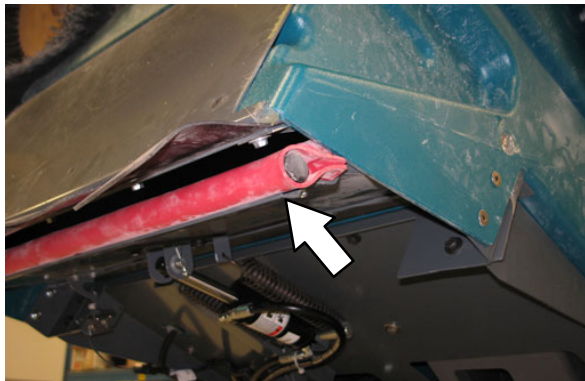
**FILTER CHAMBER INLET SEAL**

Check the filter chamber inlet seal for wear or damage every 100 hours of operation.

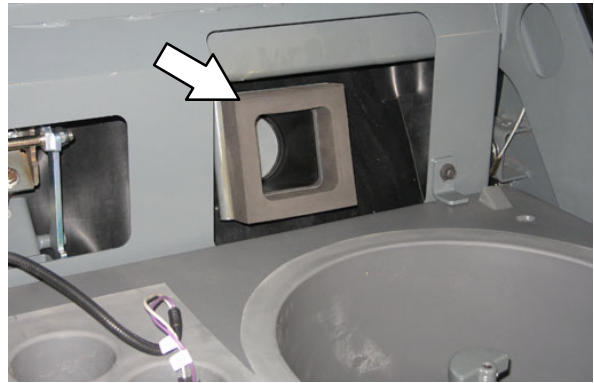
**CYCLONIC CHAMBER AND DUST TRAY FLAPS**

Check the cyclonic chamber and dust tray flaps for wear, damage, and debris buildup every 100 hours of operation or daily on machines equipped with HEPA. Inspect both flaps through the open hopper door. Both flaps should open and move freely.

If flaps do not open and move freely, remove dirt and debris preventing the flaps from opening. If necessary, use water to rinse dirt and debris from the flaps and the area around the flaps.



MAINTENANCE

CYCLONE COVER SEALS

Check the cyclone cover seals for wear or damage every 100 hours of operation. Clean dust and debris from the cyclones as necessary.

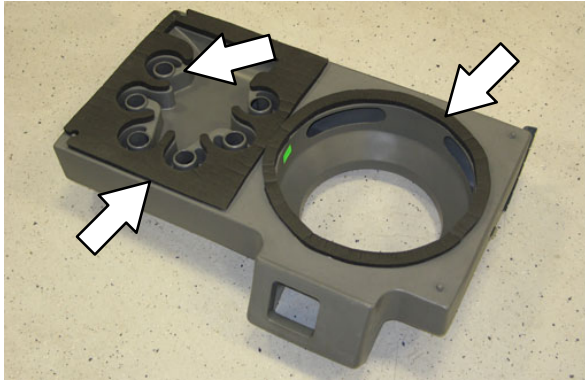

CYCLONE COVER ACCESS PORT SEAL (S/N 006266 -)

Check the cyclone cover access port seal for wear or damage every 100 hours of operation. Clean dust and debris from the seal as necessary.

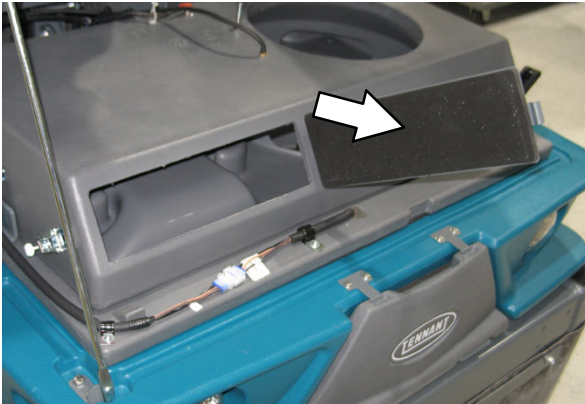

HOPPER DUST FILTER COVER SEAL

Check the hopper dust filter cover seal for wear or damage every 100 hours of operation or every 50 hours on machines equipped with HEPA. Clean dust and debris from the seal as necessary.

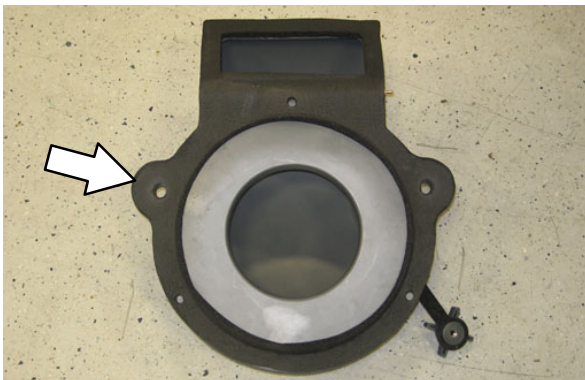

BRAKES AND TIRES

BRAKES

The mechanical brakes are located on the front wheels. The brakes are operated by the foot brake pedal and connecting rods.

Check the brake adjustment after every 200 hours of operation.

To check the brake adjustment, measure the distance from the stationary brake pedal to the point where there is resistance in the pedal movement. The distance must be between 12 mm (0.5 in) and 25 mm (1.0 in). Adjust the brakes if required.

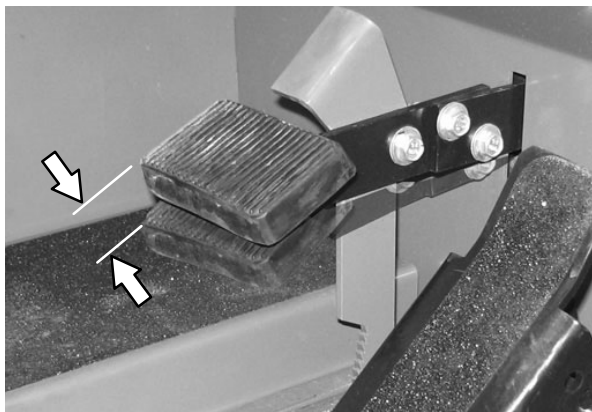

TIRES

The standard front machine tires are solid. The standard rear machine tire is pneumatic.

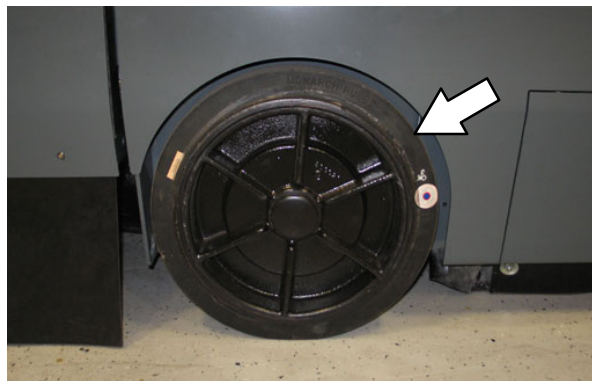

Check the front tires after every 100 hours of operation for damage. Check the rear tire pressure after every 100 hours of operation. The proper tire pressure is 795 kPa (115 psi).

REAR WHEEL

Torque the rear wheel nuts twice in the pattern shown to 122 to 155 Nm (90 to 110 ft lb) after the first 50 hours of operation, and every 800 hours of operation.

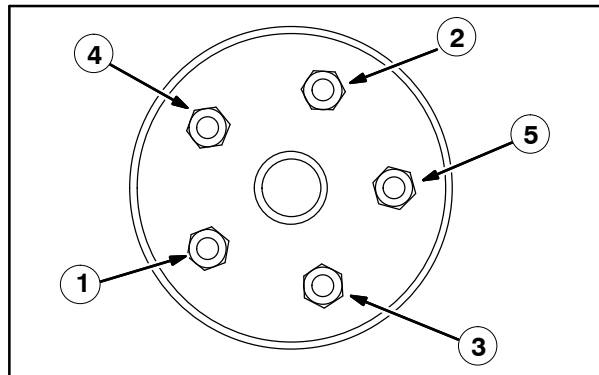

PROPELLING MOTOR

Torque the shaft nut to 270 Nm (200 ft lb) after the first 50 hours of operation and after every 800 hours thereafter.



MAINTENANCE

WET SIDE BRUSH DUST CONTROL (OPTION)

FILTER SCREENS

The wet side brush dust control has 2 filter screens. One is located in the water tank and the other under the main cover.

Remove and clean the filter screens after every 200 hours of operation.

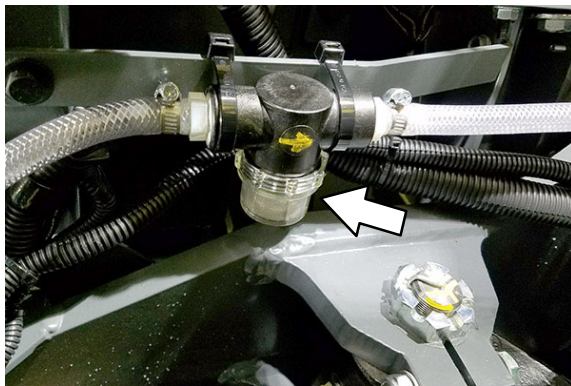
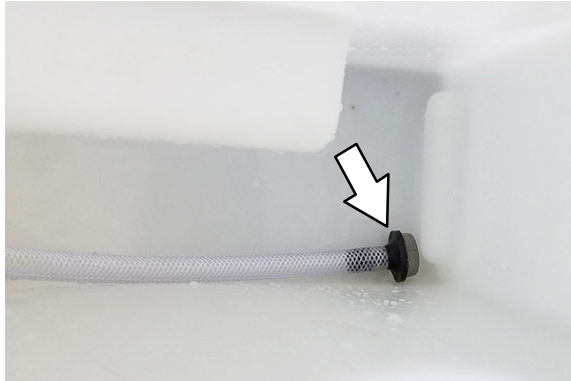

SPRAY NOZZLES

The wet side brush dust control nozzles are located above the side brush (es). Check the spray pattern after every 50 hours.

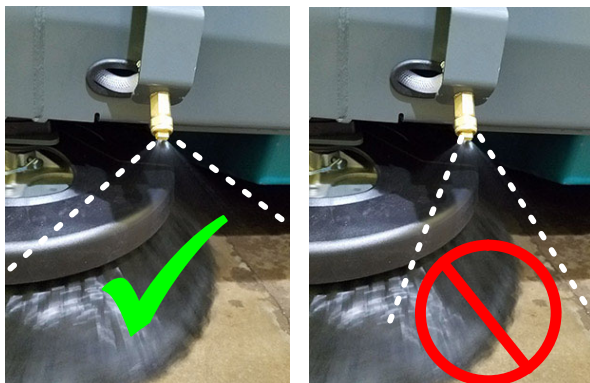

To adjust the spray pattern, use the water valve located next to the the water tank. Do not open the valve to the 90° maximum position. Optimal position is with the valve opened between 10–15°

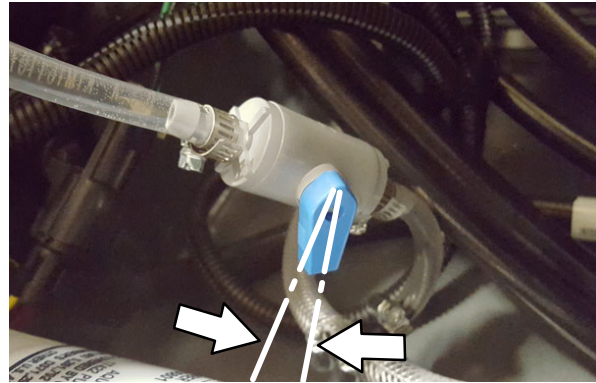

STORING THE WATER TANK

When not using the wet side brush dust control system, the tank can be stored on the main cover.

Drain the water tank.



Disconnect the 2 water hoses.

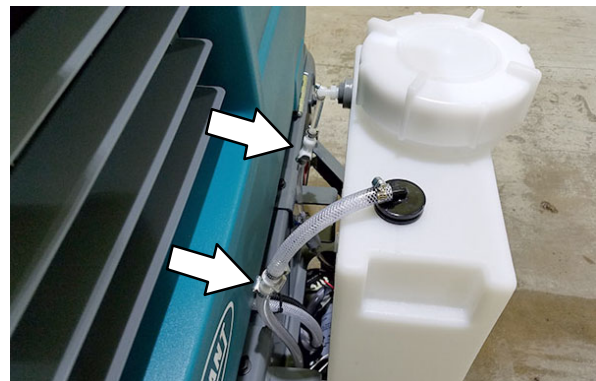

Disconnect the wire harness below the tank.

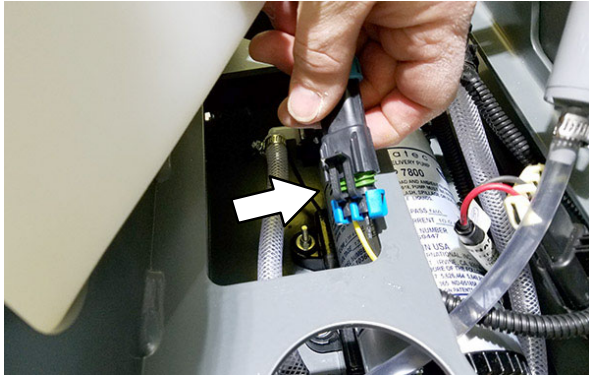

Secure the tank to the main cover with the strap.

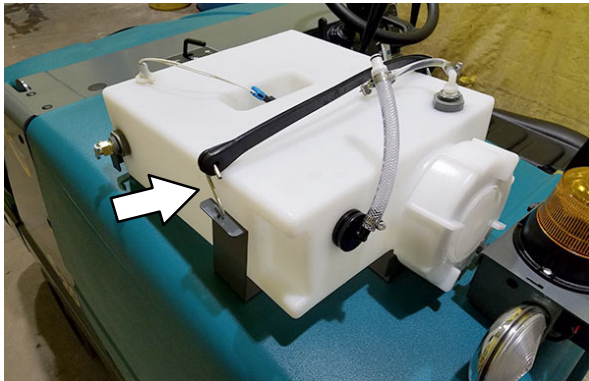

PUSHING, TOWING, AND TRANSPORTING THE MACHINE

PUSHING OR TOWING THE MACHINE

If the machine becomes disabled, it can be pushed from the front or rear, but only towed from the rear.

The propelling pump has a bypass valve to prevent damage to the hydraulic system when the machine is being pushed or towed. This valve allows a disabled machine to be moved for a *very short distance* and at a speed to not exceed 1.6 kp/h (1 mph). The machine is NOT intended to be pushed or towed a long distance or at a high speed.

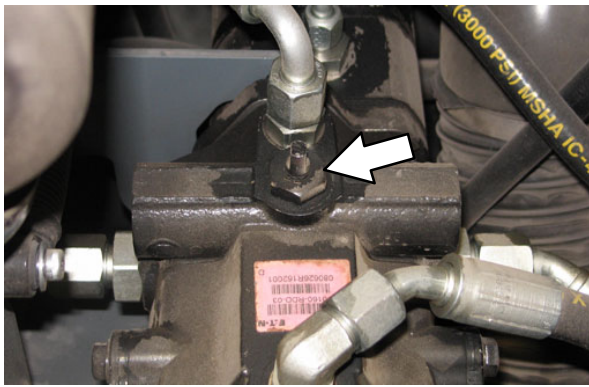

ATTENTION! Do not push or tow machine for a long distance and without using the bypass valve, or the machine hydraulic system may be damaged.

Turn the bypass valve 90° from the normal position before pushing or towing the machine. **The illustration shows the bypass valve in the pushing or towing position.**

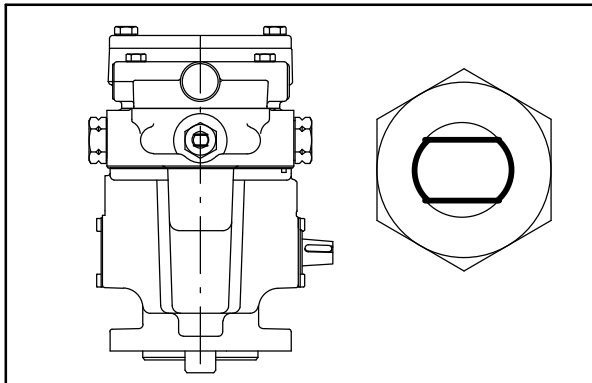

Return the bypass valve to the normal position when through pushing or towing the machine.

TRANSPORTING THE MACHINE

1. Position the machine at the loading edge of the truck or trailer.

FOR SAFETY: When loading machine onto truck or trailer, empty hopper before loading machine. Do not load/unload on ramp inclines that exceed 25% grade.

2. If the loading surface is not horizontal or is higher than 380 mm (15 in) from the ground, use a winch to load machine.

If the loading surface is horizontal AND is 380 mm (15 in) or less from the ground, the machine may be driven onto the truck or trailer.



3. To winch the machine onto the truck or trailer, attach the winching chains to the rear tie down locations. The rear tie-down locations are the holes in the sides of the machine frame near the rear bumper.

- Turn the bypass valve 90° from the normal position before winching the machine onto the truck or trailer. See *PUSHING OR TOWING THE MACHINE* section of this manual. Make sure the machine is centered.

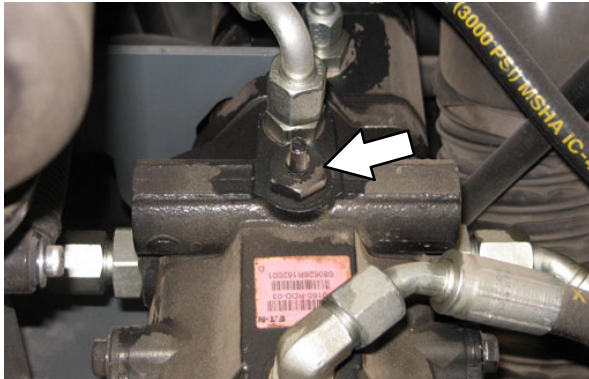

FOR SAFETY: When loading machine onto truck or trailer, use winch. Do not drive the machine onto the truck or trailer unless the loading surface is horizontal AND is 380 mm (15 in) or less from the ground.

- Position the machine onto the truck or trailer as far as possible. If the machine starts to veer off the center line of the truck or trailer, stop and turn the steering wheel to center the machine.
- Set the parking brake and block the machine tires. Tie down the machine to the truck or trailer before transporting.

The front tie-down locations are the holes in the wheel pockets at the front of the machine frame.



The rear tie-down locations are the holes in the sides of the machine frame near the rear bumper.



- If the loading surface is not horizontal or is higher than 380 mm (15 in) from the ground, use a winch to unload machine.

If the loading surface is horizontal AND is 380 mm (15 in) or less from the ground, the machine may be driven off the truck or trailer.

FOR SAFETY: When loading machine onto truck or trailer, use winch. Do not drive the machine onto the truck or trailer unless the loading surface is horizontal AND is 380 mm (15 in) or less from the ground.

- Return the bypass valve to the normal position when through loading the machine. Refer to *PUSHING OR TOWING THE MACHINE* section of this manual.

MACHINE JACKING

Empty the hopper before jacking up the machine. Jack up the machine at the designated locations. Use a hoist or jack capable of supporting the weight of the machine. Use jack stands to support the machine.

FOR SAFETY: Before leaving or servicing machine, stop on level surface, set parking brake, turn off machine, and remove key.

FOR SAFETY: When servicing machine, block machine tires before jacking machine up. Use a hoist or jack that will support the weight of the machine. Jack machine up at designated locations only. Support machine with jack stands.

The rear jacking location is the center of the rear bumper behind the back tire.

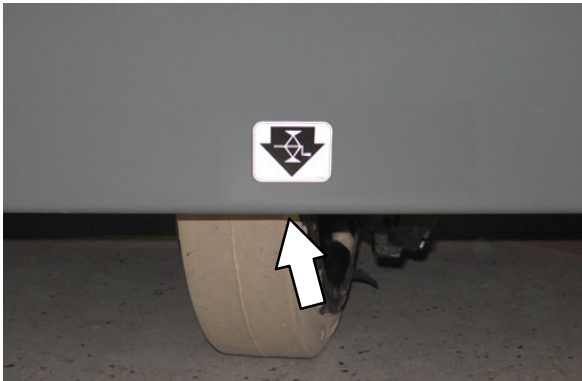

Front jacking locations are located on the frame directly in front of the front tire.



STORAGE INFORMATION

The following steps should be taken prior to storing the machine for extended periods of time.

1. Park the machine in a cool, dry area. Do not expose the machine to rain or snow. Store indoors.
2. Remove the battery, or charge battery every three months.

NOTE: To prevent potential machine damage store machine in a rodent and insect free environment.

FREEZE PROTECTION FOR WET SIDE BRUSH DUST CONTROL SYSTEM

1. Drain the water tank with the drain valve located under the tank.
2. Drain the water lines and pump by pressing on the wet side brush dust control switch to the on position. Press the switch to the off position when the wet side brush dust control light turns red.
3. Remove the wet side brush dust control filter screen, located under the main cover, and empty it.

SPECIFICATIONS

GENERAL MACHINE DIMENSIONS/CAPACITIES

Item	Dimension/capacity
Length	2090 mm (82.3 in)
Length with side brush	2248 mm (88.5 in)
Length with side brush wet dust control (option)	2340 mm (92.1 in)
Width	1230 mm (48.5 in)
Width with side brush	1260 mm (49.5 in)
Width with single side brush dry dust control (SBDC)	1464 mm (57.5 in)
Width with dual side brush dry dust control (SBDC)	1698 mm (66.8 in)
Height without overhead guard	1260 mm (49.5 in)
Height with overhead guard	2085 mm (82.1 in)
Track	1135 mm (44.7 in)
Wheelbase	1085 mm (42.7 in)
Main sweeping brush diameter	355 mm (14 in)
Main sweeping brush length	910 mm (36 in)
Side brush diameter	580 mm (23 in)
Sweeping path width with side brush	1270 mm (50 in)
Sweeping path width with dual side brushes	1575 mm (62 in)
Main sweeping brush pattern width	50 to 75 mm (2 to 3 in)
Hopper weight capacity (polyethylene hopper)	340 kg (750 lb)
Hopper weight capacity (optional steel hopper)	318 kg (700 lb)
Hopper volume capacity (polyethylene hopper)	310 L (11 ft ³)
Hopper volume capacity (optional steel hopper)	319 L (11.25 ft ³)
Dust filter area	7.4 m ² (80 ft ²)
Minimum ceiling dump height	2490 mm (98 in)
Weight – empty	1110 kg (2450 lb)
GVWR (Gross Vehicle Weight Rating)	1674 kg (3690 lb)
Protection Grade	IPX3

Values determined as per IEC 60335-2-72	Measure
Sound pressure level L_{pA}	81 dB(A)
Sound uncertainty K_{pA}	1.7 dB(A)
Sound power level L_{WA} + Uncertainty K_{WA}	100 dB(A)
Vibration – Hand–arm	<2.5m/s ²
Vibration – Whole body	<0.5m/s ²

SPECIFICATIONS

GENERAL MACHINE PERFORMANCE

Item	Measure
Maximum forward speed	10 km/h (6 mph)
Maximum reverse speed	4.8 km/h (3 mph)
Minimum aisle turn width, left	2415 mm (95 in)
Minimum turning radius, right	2113 mm (83.2 in)
Minimum turning radius, left	1625 mm (64 in)
Maximum ramp incline for loading - empty hopper	10.0 deg/17.6%
Maximum ramp incline for transporting (GVWR)	8.0 deg/14%

POWER TYPE

Engine	Type	Ignition	Cycle	Aspiration	Cylinders	Bore	Stroke
Kubota D1005	Piston	Diesel	4	Natural	3	76 mm (2.99 in)	73.6 mm (2.90 in)
	Displacement		Tennant governed power			Gross intermittent power per SAE J1995	
	1001 cc (61.1 cu in)		13.8 kw (18.5 hp) @ 2400 rpm			14.2 kw (19.0 hp) @ 2500 rpm	
	Fuel		Cooling system			Electrical system	
	Diesel Alternative: Biodiesel, no greater than B5. Fuel tank: 27.6 L (7.3 gal)		Water/ethylene glycol antifreeze			12 V nominal	
	Idle speed		(Fast) governed speed under load			Engine lubricating oil with filter	
	1350 ± 50 rpm		2500 ± 50 rpm			5.1 L (5.4 qt) 10W-30, 10W-40 or 15W-40 Engine oil, API die- sel classification CF or bet- ter.	

STEERING

Type	Power source	Emergency steering
Rear wheel, hydraulic cylinder and rotary valve controlled	Hydraulic accessory pump	Manual

HYDRAULIC SYSTEM

System	Capacity	ISO Grade Viscosity Index	Ambient Air Temperature Ranges
Hydraulic reservoir	19.3 L (5.1 gal)	ISO 100 VI 126 or higher	19° C (65° F) or higher
Hydraulic total	20.8 L (5.5 gal)	ISO 68 VI 155 or higher	7 to 43° C (45 to 110° F)
		ISO 32 VI 163 or higher	16° C (60° F) or lower

BRAKING SYSTEM

Type	Operation
Service brakes	Mechanical drum brakes (2), one per front wheel, rod actuated
Parking brake	Utilize service brakes, rod actuated

TIRES

Location	Type	Size	Pressure
Front (2)	Solid	89 x 410 mm (3.5 X 16 in)	-
Rear (1)	Pneumatic	150 x 410 mm (6 X 16 in)	795 kPa (115 psi)

MACHINE DIMENSIONS

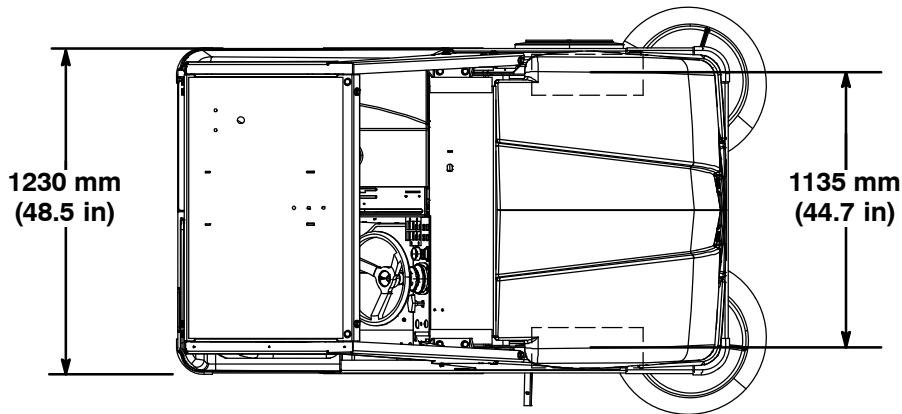

TOP VIEW

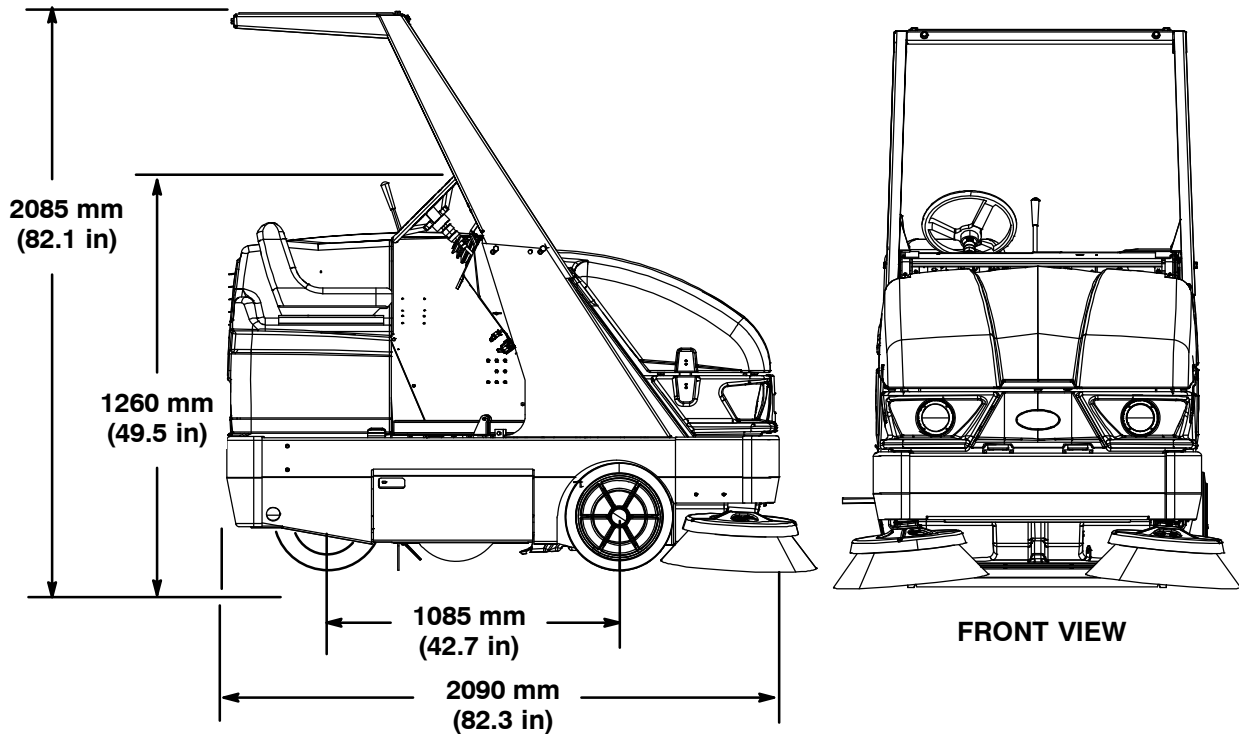

FRONT VIEW

SIDE VIEW

A

Adjust operator seat, 17
Adjusting the Main Brush Taper, 60
Adjusting the Main Brush Width, 61
Air filter indicator, 44
 Reset, 45
Aisle turn, 74

B

Battery, 46
 Charging system, Light, 14
Belts
 Engine belt, 45
 Vacuum Fan Belt, 46
Brake pedal, 12
Brakes, 67
 System specifications, 75
Brakes and Tires, 67
 Brakes, 67
 Rear Wheel, 67
 Tires, 67
Brush door seals, 64
Brush door skirts, 63
Brush Information, 18
Brushes
 Adjust side brush pattern, 62
 Checking main brush pattern, 60 – 62
 Checking side brush pattern, 62
 Door seals, 64
 Door skirts, 63
 Main brush adjustment knob, 13
 Rear skirts, 63
 Side brush adjustment knob, 13
 Side brush dust control skirts, 64
 Side brush guard, 62
 Side brush pivot, 62
Bypass valve, 70

C

Capacities, 73
Charging system light, 14
Clean the hopper, 48
Cleaning the Cyclone Assembly, 52
Cleaning the Dust Filter, 51
Cleaning the lower cyclone chamber, 53
Cleaning the lower cyclone chamber (Hepa Option), 53

Cleaning the upper cyclone chamber, 52
Clogged dust filter light, 14
Clogged hydraulic filter light, 15
Control panel
 Charging System light, 14
 Clogged dust filter light, 14
 Clogged hydraulic filter light, 15
 Engine oil pressure, 15
 Engine water temperature light, 14
 Fuel level gauge, 16
 Glow plug light, 15
 Hopper door closed light, 15
 Hopper temperature light, 14
 Operating/hazard lights switch, 16
 Parking brake light, 12
Controls
 Charging system light, 14
 Clogged dust filter light, 14
 Clogged hydraulic filter light, 15
 Engine oil pressure light, 15
 Engine water temperature light, 14
 Fuel level gauge, 16
 Glow plug light, 15
 Hopper door closed light, 15
 Hopper temperature light, 14
 Main brush adjustment knob, 13
 Main cover lever, 13
 Operating/hazard lights switch, 16
 Parking brake light, 12
 side brush adjustment knob, 13
 Steering wheel tilt handle, 13
Controls and Instruments, 9
Cooling System, 43
 Check the coolant level, 43
 Flush the radiator and the cooling system, 43
Cyclone Assembly
 Cleaning, 52
 Cleaning the lower cyclone chamber, 53
 Cleaning the lower cyclone chamber (Hepa Option), 53
 Cleaning the upper cyclone chamber, 52
Cyclone cover access port seal, 66
Cyclone cover seals, 66
Cyclone perma-filter, 56
Cyclonic Dust Tray Flaps, 65

D

Deluxe suspension seat, 17
 Dimensions, 73
 Directional pedal, 12
 Disengaging hopper support bar, 28 – 30
 Doors
 Brush
 Seals, 64
 Skirts, 63
 Hopper, Seals, 65
 Hopper access, Seal, 64
 Inner hopper access, Seal, 65
 Dust Filter
 Check Dust Filter Seal Height, 50
 Hopper, 49 – 51

E

Emptying the hopper, 25 – 27
 Engaging hopper support bar, 27 – 29
 Engine, 43
 Air filter, 44
 Air filter indicator, 44
 Belt, 45
 Clean the engine and engine compartment, 43
 Coolant temperature, Light, 14
 Cooling System, 43
 Fuel filter, 45
 Fuel Lines, 46
 Oil pressure, Light, 15
 Priming the fuel system, 46
 Specifications, 74
 Valve clearance, 45
 Engine air filter, 44
 Cleaning, 44 – 46
 Engine belt, 45
 Engine Oil, 40
 Engine oil pressure light, 15
 Engine water temperature light, 14

F

Filter Chamber Inlet Seal, 65
 Filter screen, 68
 Filters
 Check Dust Filter Seal Height, 50
 Cleaning the Dust Filter, 51
 Cyclone perma-filter, 56
 HEPA, 57
 Replacing the hopper dust filter, 49 – 51

Freeze protection, Wet dust control, 72
 Front tie down location, 71
 Front Wheel Bearings, 40
 Fuel filter, 45
 Fuel level gauge, 16
 Fuel Lines, 46
 Fuses and Relays, 47
 Relay Panel Fuses and Relays, 47

G

Gauges, Fuel level, 16
 General Machine Dimensions / Capacities, 73
 Glow plug light, 15
 Grease fittings
 Hopper lift arm pivots, 40
 Rear Wheel Support Bearing, 40

H

HEPA filter, 48, 57
 Hopper
 Access door seal, 64
 Clogged dust filter, Light, 14
 Disengaging hopper support bar, 28 – 30
 Door closed, Light, 15
 Door seals, 65
 Emptying the hopper, 25 – 27
 Engaging hopper support bar, 27 – 29
 Inner access door seal, 65
 Lift arm pivots, 40
 Lip skirt, 63
 Seals, 64
 Side skirt, 63
 Temperature, Light, 14
 Thermo Sentry, 14
 Hopper access door seal, 64
 Hopper door closed light, 15
 Hopper door seals, 65
 Hopper dust filter, 49 – 51
 Hopper dust filter cover seal, 66
 Hopper lift arm pivots, 40
 Hopper lip skirt, 63
 Hopper seals, 64
 Hopper side skirt, 63

Hopper temperature light, 14
Hopper, Clean, 48
Hour Meter, 16
How the Machine Works, 18

Hydraulic Cooler, 43
 Clean the fins, 43
Hydraulic fluid, 42
Hydraulic fluid reservoir, 41
Hydraulic Hoses, 42
Hydraulics, 41
 Check the hydraulic fluid level, 41
 Check the hydraulic hoses, 42
 Clogged hydraulic filter light, 15
 Fluid, 42 – 44
 Hydraulic Hoses, 42
 Reservoir, 41
 System specifications, 74

I

Ignition, Glow plug, Light, 15
Indicators, Hour Meter, 16
Inner hopper access door seal, 65

J

Jack points, 72
Jacking up the machine, 72

K

Knobs
 Main brush adjustment, 13
 Right side brush adjustment, 13

L

Levers
 Main cover, 13
 Steering wheel tilt handle, 13
Lights
 Charging system, 14
 Clogged Dust filter, 14
 Clogged hydraulic filter light, 15
 Engine oil pressure, 15
 Engine water temperature, 14
 Glow plug, 15
 Hopper door closed, 15
 Hopper temperature, 14
 Operating/hazard lights switch, 16
 Parking brake, 12

Lubrication, 40
 Engine Oil, 40
 Front Wheel Bearings, 40
 Rear Wheel Support Bearing, 40

M

Machine components, 8
Machine Dimensions, 75
Machine jacking, 72
Machine Operation, Pre-Operation Checklist, 20
Machine Specifications, 73 – 76
Machine Troubleshooting, 33
Main brush
 adjustment, 13
 Checking brush pattern, 60 – 62
 Door seals, 64
 Door skirts, 63
 Rear skirts, 63
Main brush adjustment knob, 13
Main Brushes, 59
 Adjusting the Taper, 60
 Adjusting the Width, 61
 Replacing or Rotating the Main Brushes, 59
Main Brushes, Adjusting the Taper, 60
Main Brushes, Adjusting the Width, 61
Main Brushes, Replacing or Rotating, 59
Main cover, Lever, 13
Main cover lever, 13
Maintenance, 35 – 59
Maintenance Chart, 34, 36

O

Operating temperature, 19
Operating/hazard lights switch, 16
Operation, 8 – 32
Operation of controls, 12
Operator seat, 17
Option, HEPA Filter, 48
Options, 30 – 32
 Clogged dust filter light, 14
 Operating/hazard lights switch, 16
 Side brush dust control skirts, 64
 Tower bumpers, 31
 Vacuum Wand, 30
 Wet side brush dust control system, Operation,
 32 – 34

P

- Parking brake light, 12
- Parking brake pedal, 12
- Pedals
 - Brake pedal, 12
 - Directional pedal, 12
 - Parking brake pedal, 12
- Pivots
 - Hopper lift arm, 40
 - Side brush, 62
- Pre-Operation Checklist, 20
- Priming the fuel system, 46
- Propelling Motor, 67
 - Torque shaft nut, 67
- Pushing or Towing the Machine, 70
 - Bypass valve, 70
- Pushing the Machine, 70
- Pushing, Towing, and Transporting the Machine, 70
 - Pushing or Towing the Machine, 70
 - Transporting the Machine, 70

R

- Radiator, 43
 - Check hoses and clamps, 43
 - Clean core exterior, 43
- Rear skirts, 63
- Rear tie down location, 71
- Rear Wheel Support Bearing, 40
- Rear Wheel, Torque, 67
- Relay Panel Fuses and Relays, 47
- Replacing or Rotating the Main Brushes, 59
- Replacing the hopper dust filter, 49 – 51
- Replacing the Side Brush, 61
- Reset air filter indicator, 45
- Rotate the side brush guard, 62

S

- Safety
 - Disengaging hopper support bar, 28 – 30
 - Engaging hopper support bar, 27 – 29
 - Labels, 6 – 8
 - Precautions, 4 – 6

- Seals, 63 – 66
 - Brush doors, 64
 - Cyclone cover access port seal, 66
 - Cyclone cover seals, 66
 - Filter Chamber Inlet Seal, 65
 - Hopper, 64
 - Hopper access door, 64
 - Hopper door, 65
 - Hopper dust filter cover seal, 66
 - Inner hopper access door, 65
- Seat
 - Adjustment, 17
 - Deluxe suspension, 17
- Seat belts, 17
- Seat, Operator, 17
- Side Brush, 61
 - Adjust the pattern, 62
 - adjustment, 13
 - Dust control skirts, 64
 - Guard, 62
 - Pivot, 62
 - Replacing the Side Brush, 61
- Side brush down pressure knob, 13
- Side brush dust control, Wet, Operation, 32 – 34
- Side brush dust control skirts, 64
- Side brush guard, 62
- Side brush pivot, 62
- Side Brush, Adjusting, 62
- Side Brush, Replacing, 61
- Side brush(es), Checking brush pattern, 62
- Skirts, 63 – 66
 - Brush doors, 63
 - Hopper Lip, 63
 - Hopper side, 63
 - Rear, 63
 - Side brush dust control, 64
- Skirts and Flaps, Cyclonic Dust Tray Flap, 65
- Specifications, 73 – 76
 - Braking system, 75
 - General Machine Dimensions / Capacities, 73 – 76
 - Hydraulic system, 74
 - Machine Capacities, 73
 - Machine Dimensions, 73
 - Machine performance, 74
 - Power type, 74
 - Steering, 74
 - Tires, 75

Spray nozzles, 68
Starting the machine, 21
Steering, Specifications, 74
Steering wheel tilt handle, 13
Stop sweeping, 24
Stop the machine, 22 – 24
Storage Information, 72
 Storing the Machine, 72
Storing machine, Freeze protection, 72
Sweeping, 23 – 25
Switches
 Operating/hazard lights, 16
 Wet side brush dust control switch, 32
Symbol definitions, 10 – 12

T

Temperature, Operating, 19
Thermo Sentry, 14
Tie down location
 Front, 71
 Rear, 71
Tires, 67
 Specifications, 75
Tower bumpers (Option), 31
Towing the Machine, 70
Transporting the Machine, 70
Travel speed, 74

V

Vacuum fan, Belt, 46
Vacuum fan belt, 46
Vacuum Wand, 30
Valve clearance, 45
Valves, 45
 Intake and exhaust, 45

W

Water tank, 68
Wet side brush dust control, 68
Wet side brush dust control (Option)
 Filter screen, 68
 Spray nozzles, 68
 Water tank, 68
Wet side brush dust control switch, 32
Wet side brush dust control system, Operation, 32
 – 34
Wheels, 67
While operating the machine, 19