

# Genie XS

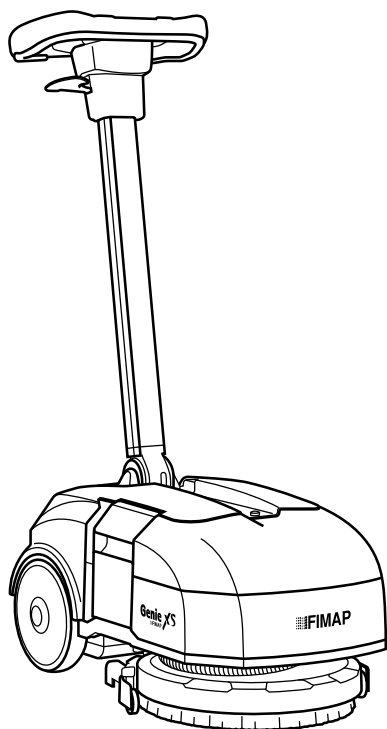

PROFESSIONAL MICRO AUTOSCRUBBER

*USE AND MAINTENANCE MANUAL*

 **FIMAP**<sup>®</sup>



TRANSLATION OF THE ORIGINAL INSTRUCTION DOC. 10049257 - Ver. AD - 09-2015



## CONTENTS

<b>CONTENTS</b> .....	<b>1</b>
<b>SYMBOLS USED IN THE MANUAL</b> .....	<b>3</b>
<b>PURPOSE AND CONTENT OF THE MANUAL</b> .....	<b>3</b>
<b>TARGET GROUP</b> .....	<b>3</b>
<b>STORING THE USE AND MAINTENANCE MANUAL</b> .....	<b>3</b>
<b>ON DELIVERY OF THE APPLIANCE</b> .....	<b>3</b>
<b>INTRODUCTORY COMMENT</b> .....	<b>3</b>
<b>IDENTIFICATION DATA</b> .....	<b>4</b>
<b>TECHNICAL DESCRIPTION</b> .....	<b>4</b>
<b>INTENDED USE</b> .....	<b>4</b>
<b>SAFETY</b> .....	<b>4</b>
<b>SERIAL NUMBER PLATE</b> .....	<b>4</b>
<b>TECHNICAL DATA</b> .....	<b>5</b>
<b>GENERAL SAFETY REGULATIONS</b> .....	<b>6</b>
<b>SYMBOLS USED ON THE APPLIANCE</b> .....	<b>9</b>
<b>PREPARING THE APPLIANCE</b> .....	<b>9</b>
<i>HANDLING THE PACKED APPLIANCE</i> .....	<b>9</b>
<i>HOW TO UNPACK THE APPLIANCE</i> .....	<b>9</b>
<i>HOW TO TRANSPORT THE APPLIANCE</i> .....	<b>10</b>
<i>MAIN COMPONENTS OF THE APPLIANCE</i> .....	<b>10</b>
<i>MAIN APPLIANCE BODY COMPONENTS</i> .....	<b>10</b>
<i>MAIN SOLUTION TANK COMPONENTS</i> .....	<b>11</b>
<i>MAIN RECOVERY TANK COMPONENTS</i> .....	<b>11</b>
<i>MAIN VACUUM COVER COMPONENTS</i> .....	<b>11</b>
<i>MAIN STEERING COLUMN CONTROL COMPONENTS</i> .....	<b>11</b>
<i>MAIN HANDLEBAR CONTROL COMPONENTS</i> .....	<b>12</b>
<i>MAIN BATTERY CHARGING BASE COMPONENTS</i> .....	<b>12</b>
<i>APPLIANCE SAFETY</i> .....	<b>12</b>
<i>BATTERY TYPE</i> .....	<b>13</b>
<i>BATTERY MAINTENANCE AND DISPOSAL</i> .....	<b>13</b>
<i>INSERTING THE BATTERY INTO THE APPLIANCE</i> .....	<b>13</b>
<i>REMOVING THE BATTERY FROM THE APPLIANCE</i> .....	<b>14</b>
<i>RECHARGING THE BATTERY</i> .....	<b>14</b>
<i>CONTROL HANDLEBAR ADJUSTMENT</i> .....	<b>16</b>
<i>BATTERY CHARGE LEVEL INDICATOR</i> .....	<b>16</b>
<i>HOURLY METER</i> .....	<b>16</b>
<i>FILLING THE SOLUTION TANK</i> .....	<b>16</b>
<i>DETERGENT SOLUTION</i> .....	<b>18</b>
<i>INSERTING THE BRUSH INTO THE APPLIANCE</i> .....	<b>18</b>
<b>PREPARING TO WORK</b> .....	<b>18</b>
<b>WORK</b> .....	<b>19</b>
<i>STARTING WORK</i> .....	<b>19</b>
<i>"PRE-WASH" WORKING PROGRAM</i> .....	<b>20</b>
<i>REGULATING THE DETERGENT</i> .....	<b>21</b>

OVERFLOW DEVICE.....	21
<b>AT THE END OF THE WORK.....</b>	<b>22</b>
<b>MAINTENANCE.....</b>	<b>23</b>
RECOMMENDED MAINTENANCE OPERATIONS .....	23
CHECKING AND CLEANING THE RECOVERY TANK.....	24
CHECKING AND CLEANING THE VACUUM COVER.....	25
CHECKING AND CLEANING THE BRUSH .....	26
CHECKING AND CLEANING THE SQUEEGEE BODY.....	26
CHECKING AND CLEANING THE VACUUM HOSE .....	27
CHECKING AND CLEANING THE SOLUTION FILTER .....	28
CHECKING AND CLEANING THE SOLUTION TANK .....	28
<b>TROUBLESHOOTING .....</b>	<b>30</b>
<b>DISPOSAL .....</b>	<b>32</b>
<b>SELECTION AND USE OF THE BRUSH.....</b>	<b>32</b>
<b>EC DECLARATION OF CONFORMITY.....</b>	<b>32</b>

The descriptions contained in this document are not binding. The company therefore reserves the right to make any modifications at any time to elements, details, or accessory supply, as considered necessary for reasons of improvement or manufacturing/commercial requirements. The reproduction, even partial, of the text and drawings contained in this document is prohibited by law.

**The company reserves the right to make any technical and/or supply modifications. The images are shown as a reference only, and are not binding as to the actual design and/or equipment.**

## SYMBOLS USED IN THE MANUAL



**Open book symbol with an "i":**  
Indicates the need to consult the instruction manual.



**Open book symbol:**  
Tells the operator to read the manual before using the appliance.



**Covered place symbol:**  
the operations preceded by this symbol must always be carried out in a dry, covered area.



**Warning symbol:**  
Carefully read the sections marked with this symbol and observe the indications, for the safety of the operator and the appliance.



**Protective gloves symbol:**  
Always wear protective gloves, to avoid the risk of serious injury to your hands.



**Moving trolley warning symbol:**  
Indicates that the packed product should be handled with suitable lifting means that comply with the legal requirements.



**Explosion risk symbol:**  
indicates that the battery may explode in certain conditions, if not handled in accordance with the directives indicated in the manufacturer's manual.

## PURPOSE AND CONTENT OF THE MANUAL

The aim of this manual is to provide customers with all the information needed to use the appliance in the safest, most appropriate and most autonomous way. It includes information concerning technical aspects, safety, operation, appliance downtime, maintenance, spare parts and scrapping. Operators and qualified technicians must read

the instructions in this manual carefully before carrying out any operation on the appliance. If in doubt about the correct interpretation of instructions, contact your nearest Customer Service Centre to obtain the necessary clarifications.

## TARGET GROUP

This manual is aimed at operators and qualified technicians responsible for appliance maintenance. Operators must not perform operations that should be carried out by qualified technicians. FIMAP

SpA cannot be held liable for damages resulting from failure to comply with this prohibition.

## STORING THE USE AND MAINTENANCE MANUAL

The Use and Maintenance Manual must be stored in its special pouch close to the appliance, protected from liquids and anything

else that could compromise its legibility.

## ON DELIVERY OF THE APPLIANCE

When the machine is delivered to the customer, an immediate check must be performed to ensure all the material mentioned in the shipping documents has been received, in addition to verifying that the equipment has not been damaged during transportation. If

this is the case, the carrier must ascertain the extent of the damage at once, informing our customer service office. It is only by prompt action of this type that the missing material can be obtained, and compensation for damage successfully claimed.

## INTRODUCTORY COMMENT

Any type of equipment can only work properly and effectively if used correctly and kept in full working order by performing the maintenance operations described in the attached documentation. You should therefore read this instruction manual carefully, consulting it again if issues arise while using the machine. If necessary, remember that

our assistance service (organised in collaboration with our dealers) is always available for advice or direct intervention.

## IDENTIFICATION DATA

For technical assistance or to request replacement parts, always give the model, the version and serial number written on the serial number plate.

## TECHNICAL DESCRIPTION

The **Genie XS** is a scrubbing machine that is able to clean a wide range of flooring and dirt types by means of the mechanical action of the discoidal brush and the chemical action of a water-detergent solution. As it advances, it also collects the dirt that has been

removed and the detergent solution that has not been absorbed by the floor. **The appliance must only be used for this purpose.**

## INTENDED USE

This scrubbing machine was designed and built for the cleaning (scrubbing and drying) of smooth, compact flooring in the commercial, residential and industrial sectors by a qualified operator in proven safety conditions. The scrubbing machine is not suitable for cleaning rugs or carpets. The appliance is only suitable for use in indoor - or at least covered - areas.



**ATTENTION:** The appliance is not suitable for use in the rain, or under jets of water.

**IT IS FORBIDDEN** to use the appliance for picking up dangerous dusts or inflammable liquids in places with an explosive atmosphere. In addition, it is not suitable as a means of transport for people or objects.

## SAFETY

Operator cooperation is paramount for accident prevention. No accident prevention programme can be effective without the full co-operation of the operator who is directly responsible for machine operation. The majority of occupational accidents that happen both in the workplace or whilst moving are caused by failure to respect

the most basic safety rules. An attentive, careful operator is most effective guarantee against accidents and is fundamental in order to implement any prevention programme.

## SERIAL NUMBER PLATE

The serial number plate is located on the inside of the appliance in the front end of the frame, indicating its general characteristics (in particular, the serial number). The serial number is a very important piece of information and should always be provided together with any request for assistance or when purchasing spare parts.

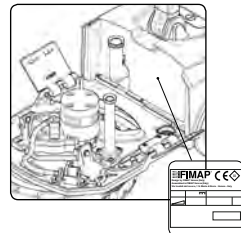

TECHNICAL DATA	U/M	Genie XS
Working width	mm	280
Squeegee width	mm	325
Working capacity, up to	m <sup>2</sup> /h	560
Maximum gradient with full load	%	2
Total power	W	255
Disc brush	no. / Ø mm	1 / 280
Brush motor	V/W	36 / 90
Disc brush rotations	rpm	150
Maximum pressure on the brush	kg	10
Vacuum motor	V/W	36 / 150
Suction vacuum	mbar	22.5
Vacuum cleaner (Eco-mode)	mbar	15
Rear wheels (Number / (Diameter / Width))	no. / (Ø mm / mm)	2 / (160 / 30)
Solution tank	l	3
Recovery tank	l	3.6
Machine length	mm	555
Machine length (Handlebar in maintenance position)	mm	895
Machine body height (Control handlebar joint)	mm	290
Control handlebar height (Handlebar in resting position)	mm	1050
Machine height (Handlebar in maintenance position)	mm	350
Machine width (with squeegee)	mm	375
Rated battery voltage	V	36.5
Battery weight	kg	1.4
Machine weight (machine + brush + squeegee)	kg	18
Machine weight in transport (machine + battery + brush + squeegee)	kg	20
Machine weight in running order (machine + battery+ water + brush + squeegee)	kg	23
Sound pressure level (ISO 11201) - L pA	dB (A)	<70
Uncertainty KpA	dB (A)	1.5
Hand vibration level (ISO 5349)	m/s <sup>2</sup>	<2.5
Uncertainty of measurement of vibrations		-

## GENERAL SAFETY REGULATIONS

The regulations below must be carefully followed in order to avoid harm to the operator and damage to the appliance.

### **WARNING:**

- Carefully read the labels on the appliance. Do not cover them for any reason and replace them immediately if they become damaged.
- The appliance must always be stored and used in a closed place.
- The appliance must be only used by authorised, trained personnel.
- Do not use the appliance on surfaces with an inclination greater than the one shown on the serial number plate.
- The appliance is not suitable for cleaning rough or uneven floors. Do not use the appliance on slopes.
- If the battery recharge cable is damaged, contact an authorised service centre immediately.
- In the event of danger, promptly remove the battery from the rear part of the appliance (refer to the “REMOVING THE BATTERY” paragraph).
- For all maintenance interventions, switch off the machine using the main switch and remove the battery.
- To prevent the appliance from being activated accidentally, the power supply must be disconnected, the appliance must be switched off using the main switch, and the battery must be removed.
- Children must be supervised to ensure they do not play with the device.
- When using the appliance, pay attention to other people and especially to children.
- Only use the brushes supplied with the machine, or those specified in the “CHOOSING AND USING THE BRUSHES” paragraph of the instruction manual. The use of other brushes could compromise safety levels.



- The appliance must only be powered with a voltage equal to that shown on the serial number plate.
- When left unattended, the appliance must be protected from unintentional movements.



The appliance must not be transported or parked in its idle position when the solution tank and recovery tank are full.

### **WARNING:**

- The appliance must not be used or kept outdoors, in damp conditions or directly exposed to rain.
- The appliance must be stored in an enclosed area with a temperature between  $-25^{\circ}\text{C}$  and  $+55^{\circ}\text{C}$ .
- Conditions of use: room temperature between  $0^{\circ}\text{C}$  and  $40^{\circ}\text{C}$ , with relative humidity between 30 and 95%.
- The socket for the battery power cable must have an earth connection in compliance with the regulatory standards.
- The appliance does not cause harmful vibrations.
- Never pick up gases, explosive/inflammable liquids or powders, nor acids and solvents! These include gasoline, paint thinners and fuel oil (which, when mixed with the vacuum air, can form explosive vapours or mixtures), and also non-diluted acids and solvents, acetones, aluminium and magnesium powders. These substances may also corrode the materials used to construct the appliance.
- If the appliance is to be used in dangerous areas (for example, gas stations), ensure that all relevant safety regulations are observed. The appliance must never be used in environments with a potentially explosive atmosphere.
- Do not place any liquid containers on the appliance.
- In the event of a fire, use a powder extinguisher. Do not use water.

- Adapt the speed to the adhesion conditions.
- Avoid working with the brushes when the machine is standing still, so as not to damage the floor.
- Do not knock against shelving or scaffolding, where there is a danger of falling objects. The operator must always be equipped with the appropriate safety devices (gloves, shoes, helmet, goggles, etc.).
- If the appliance does not work properly, check this is not caused by failure to carry out routine maintenance. Otherwise, ask for intervention of the authorised technical assistance centre.
- If you need to replace any components, request the ORIGINAL spare parts from an Authorised dealer and/or Retailer.
- Restore all electrical connections after any maintenance interventions.
- Have the appliance checked by an authorised technical assistance centre every year.
- When disposing of consumable materials, observe the laws and regulations in force. When, after years of valuable work, your appliance needs to be finally decommissioned, dispose of the materials contained within it appropriately, bearing in mind that the appliance is made of fully recyclable materials.

## SYMBOLS USED ON THE APPLIANCE



**Main switch symbol:**

located on the central rear part of the appliance, to indicate the main switch.



**Battery power supply symbol**

Used on the rear of the appliance, to indicate the position of the battery power supply.



**Battery power supply disconnection symbol**

This symbol is used at the rear of the appliance to indicate the direction in which the battery stop lever must be pulled in order to allow for the removal of the battery power supply.



**Lifting point symbol:**

located on the front and rear of the appliance, to indicate the lifting points.



**Squeegee in "WORK" position symbol:**

This symbol is used at the rear of the appliance to indicate the direction in which the squeegee control handle must be turned in order to place in the working position.



**Squeegee in "RESTING" position symbol:**

This symbol is used at the rear of the appliance to indicate the direction in which the squeegee control handle must be turned in order to place in the resting position.



**Tank empty symbol:**

Symbol used on the device to indicate the position of the tank discharge plug.



**Warning - danger of burns symbol:**

Indicates the risk of burns due to the hot surface.



**Warning symbol not to rotate the appliance:**

Indicates that the appliance must not be rotated when the tanks are full.

## PREPARING THE APPLIANCE

### HANDLING THE PACKED APPLIANCE

Since the packaging elements (plastic bags, staples, etc.) are a potential source of danger, they should not be left within the reach of children, disabled persons, etc.

The overall weight of the appliance with packaging is 25 kg (weight of empty machine plus packaging).

The dimensions of the package are as follows:

	U/M	Genie XS
A	cm	94
B	cm	35
C	cm	39

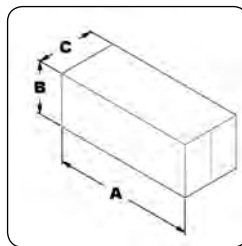

### HOW TO UNPACK THE APPLIANCE

The appliance is enclosed within special packaging; to remove the appliance from the packaging proceed as follows:

1. Place the lower part of the outer packaging in contact with the floor.



**ATTENTION:** Use the pictograms printed on the box as reference.

2. Open the outer package.



**ATTENTION:** Users are advised to always wear protective gloves, to avoid the risk of serious injury to hands.

3. Remove the cardboard accessories container.

4. Remove the appliance from the packaging using the handle designed for this purpose.



**ATTENTION:** Do not use the control handlebar to remove the appliance from its packaging, as this may lead to damage.



**ATTENTION:** it is recommended that all the packaging components be kept for any future transportation of the appliance.

**HOW TO TRANSPORT THE APPLIANCE**

To safely transport the appliance, proceed as follows:

1. Take all necessary steps to ensure that the device is in a safe condition (see "MACHINE SAFETY.™").
2. Block the handlebar in the horizontal position. Push the steering column control stop lever (1) in the direction indicated by the arrow (Fig.1) and turn the steering column control into the horizontal position (Fig.2).

**ATTENTION:** during this process, keep the control handlebar still, in order to prevent the appliance from moving accidentally.

3. When the handlebar is in the horizontal position, release the stop lever (1) to lock the handlebar.

4. It is now possible to safely transport the appliance.

**ATTENTION:** If you need to lift the appliance, use the moulded front (2) and rear (3) handles. The handle (4) on the steering column control can also be used (Fig.3).

**ATTENTION:** Users are advised to always wear protective gloves, to avoid the risk of serious injury to hands.

**ATTENTION:** When transporting the appliance on vehicles, secure it according to the directives in force so that it cannot slide or tip over.

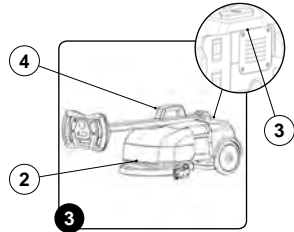
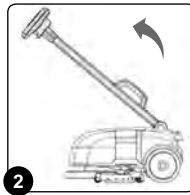
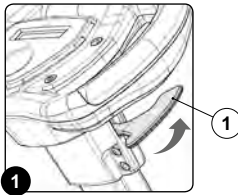

**MAIN COMPONENTS OF THE APPLIANCE**

The basic components of the appliance are as follows:

1. Appliance body.
2. Solution tank pre-assembly.
3. Solution tank pre-assembly.
4. Vacuum cover pre-assembly.
5. Control handlebar.
6. Battery.
7. Battery charger base pre-assembly.

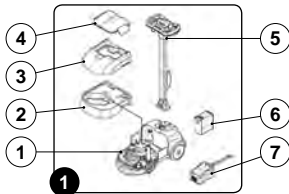

**MAIN APPLIANCE BODY COMPONENTS**

The appliance body components are identified as follows:

1. Disc brush.
2. Squeegee body.
3. Rear lifting handle.
4. Detergent solution filter.
5. Air vacuum hose vacuum motor inlet.
6. Tank stop lever.
7. Vacuum hose duct.
8. Main switch.
9. Rear lifting handle.
10. Squeegee body stop knob.
11. Battery compartment.

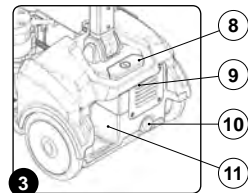
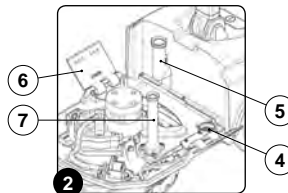
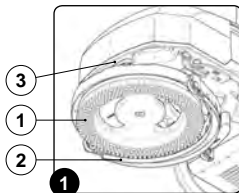

### MAIN SOLUTION TANK COMPONENTS

The pre-assembly solution tank components are identified as follows:

1. Tank filler plug.
2. Tank discharge plug.
3. Tank lifting handle.
4. Tank safety valve.

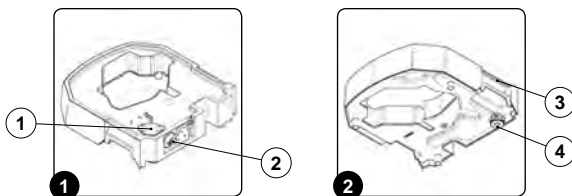

### MAIN RECOVERY TANK COMPONENTS

The pre-assembly recovery tank components are identified as follows:

1. Tank discharge plug.
2. Tank lifting handle.



### MAIN VACUUM COVER COMPONENTS

The pre-assembly vacuum cover components are identified as follows:

1. Vacuum cover stop lever.
2. Floating support.
3. Floats.

4. Dirty water entry hole.
5. Dirty water exit hole.
6. Vacuum motor air inlet hole.
7. Vacuum motor air outlet hole.
8. Cover seals.

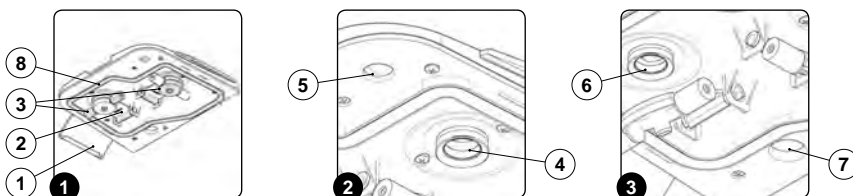

### MAIN STEERING COLUMN CONTROL COMPONENTS

The steering column control base components are identified as follows:

1. Control handlebar.
2. Steering column control stop lever.
3. Steering column control.

4. Steering column control fulcrum.
5. Lifting handle.

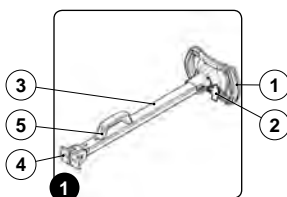

### MAIN HANDLEBAR CONTROL COMPONENTS

The handlebar control components are identified as follows:

- |  |  |
|--|--|
| 1. "AUTOMATIC" mode button.                        | 4. "VACUUM MOTOR" activation-de-activation button. |
| 2. "ECO - MODE" button.                            | 5. Display.  |
| 3. "DETERGENT SOLUTION" regulation control button. | 6. Dead man's lever.                               |

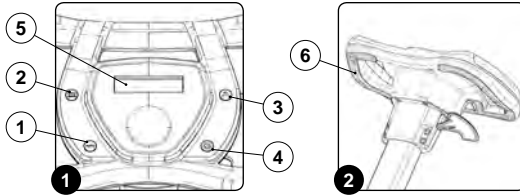

### MAIN BATTERY CHARGING BASE COMPONENTS

The basic components of the battery charger base are identified as follows:

- |  |   |
|--|---|
| 1. Battery.                                | 6. Green LED - power supply continuity to battery charger |
| 2. Battery charger base.                   | 7. Red LED - battery charge level.                        |
| 3. Battery charger base power supply cord. | 8. Battery charger base socket.                           |
| 4. Battery charger main switch.            | 9. Battery charger base power supply cable plug.          |
| 5. Battery stop lever.                     | 10. Battery charger base connection cable plug.           |

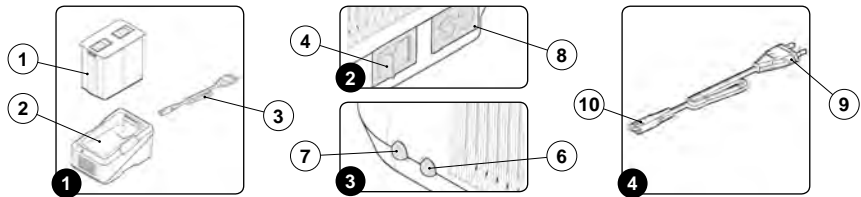

### APPLIANCE SAFETY

The stages for making the appliance safe, and thereby allowing all the operations to be carried out in complete safety, are as follows:

- If the appliance is working, turn it off via the main switch (1) (Fig. 1).
- Make sure the recovery tank is empty, otherwise empty it completely (read paragraph "[CHECKING AND CLEANING THE RECOVERY TANK](#)").
- Make sure the solution tank is empty, otherwise empty it completely (read paragraph "[CHECKING AND CLEANING THE SOLUTION TANK](#)").
- Block the handlebar in the vertical position. Push the steering column control stop lever (2) in the direction indicated by the arrow (Fig.2) and turn the steering column control into the vertical position (Fig.3).

**⚠ ATTENTION:** During this operation, do not rest your foot on the appliance.

- When the handlebar is in the vertical position, release the stop lever (2) to lock the handlebar.
- To remove the power battery (4) from the appliance, you must first free it by shifting the stop levers (3) in the direction of the two arrows (Fig. 4). Remove the battery by lifting out of the appliance (Fig. 5).

**⚠ ATTENTION:** The place this operation is carried out should comply with current environmental protection regulations.

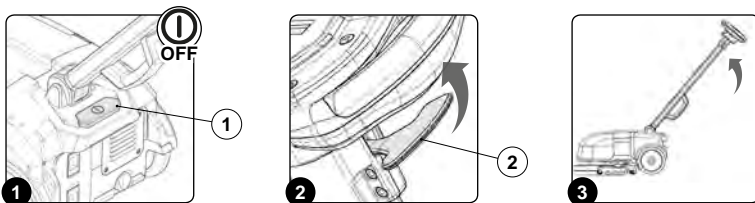

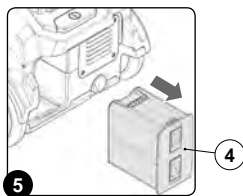
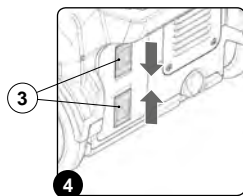

### BATTERY TYPE

To power the appliance, use only the battery supplied in the package or by a specialised technician. **OTHER BATTERY TYPES CANNOT BE USED.** The appliance is powered by a lithium-ion battery. The battery compartment can accommodate a single battery slot at 36.5V.

### BATTERY MAINTENANCE AND DISPOSAL

For maintenance and recharging, respect the instructions provided by the battery manufacturer. **THE BATTERY IS CLASSIFIED AS DANGEROUS WASTE, AND AS SUCH, IT IS COMPULSORY TO TAKE IT TO AN AUTHORISED SERVICE CENTRE.**

For good battery maintenance, follow these indications:

- Do not attempt to open the battery for any reason whatsoever. Avoid any contact with the liquid that seeps out of damaged batteries. If necessary, rinse the area of skin which came into contact with the liquid in water; in case of contact with eyes, rinse thoroughly and seek medical advice.
- Do not let the battery get dirty or wet.
- The battery must not be exposed to excessive heat (e.g. rays of sunshine, flames, etc.). Do not leave the battery in places where the temperature could exceed 40°C.
- The battery contacts must not touch metal parts, to avoid any risk of short-circuits.
- The battery must be kept far from metal objects, to avoid any risk of short-circuits.
- Do not throw the battery into the fire.
- Do not throw the battery away with domestic waste; respect the disposal regulations in force in the country where the appliance is used.

For good battery recharger maintenance, follow these indications:

- Always recharge the battery at a room temperature between 10°C and 40°C. Recharge the battery using the power supply unit supplied with the appliance. Do not attempt to recharge damaged batteries.
- Only use the power supply unit delivered with the appliance to recharge the battery supplied by the manufacturer or by a specialised technician. Other batteries could explode, causing harm to people and damage to property.
- The voltage rate indicated on the plate in the battery charger must correspond to the mains voltage.

- Do not use the battery charger in potentially explosive environments.
- The battery charger contacts must not touch metal parts, to avoid any risk of short-circuits.
- Never attempt to recharge the primary cell batteries: danger of explosion.
- Never attempt to recharge damaged batteries.
- Every time you want to use the battery charger and the battery, first make sure they are not damaged. Do not use damaged appliances. Have faulty parts repaired by the staff of a technical assistance centre.
- Have any faulty supply wires replaced immediately.
- Do not let the power supply unit get dirty or wet.
- Do not open the power supply unit.
- Do not connect the power supply unit to probes.
- The batteries must be clean and dry when they are inserted in the battery charger. Do not use the battery charger if the battery holder support is dirty or wet.

**ATTENTION:** the battery charger must only be used in a covered place.

**ATTENTION:** read this manual before using the appliance or carrying out any maintenance work.

**ATTENTION:** if the battery is handled in the wrong way, it could explode or release acids. This could cause burns and injuries to the people nearby.

**ATTENTION:** when the battery is run down or damaged, respect the disposal regulations in force in the country of use.

### INSERTING THE BATTERY INTO THE APPLIANCE

To insert the battery into the battery holder compartment proceed as follows:

1. Take all necessary steps to ensure that the device is in a safe condition (see "MACHINE SAFETY").
2. Insert the battery (1) in its compartment (2) on the rear left side of the appliance, making sure the battery poles (3) are facing towards the upper part of the appliance (Fig.1).

3. Press the battery until the clamp (4) is in place (Fig.2).

**ATTENTION:** during this process, keep the control handlebar still, in order to prevent the appliance from moving accidentally.

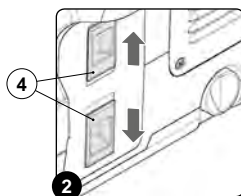
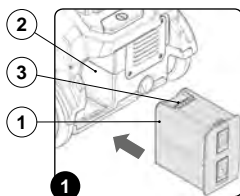

**REMOVING THE BATTERY FROM THE APPLIANCE**

To remove the battery, proceed as follows:

1. If the appliance is working, turn it off via the main switch (1) (Fig. 1).
2. Block the handlebar in the vertical position. Push the steering column control stop lever (2) in the direction indicated by the arrow (Fig.2) and turn the steering column control into the vertical position (Fig.3).

**! ATTENTION:** During this operation, do not rest your foot on the appliance.

3. To remove the power battery (4) from the appliance, you must first free it by shifting the stop levers (3) in the direction of the two arrows (Fig.4). Remove the battery by lifting out of the appliance (Fig.5).

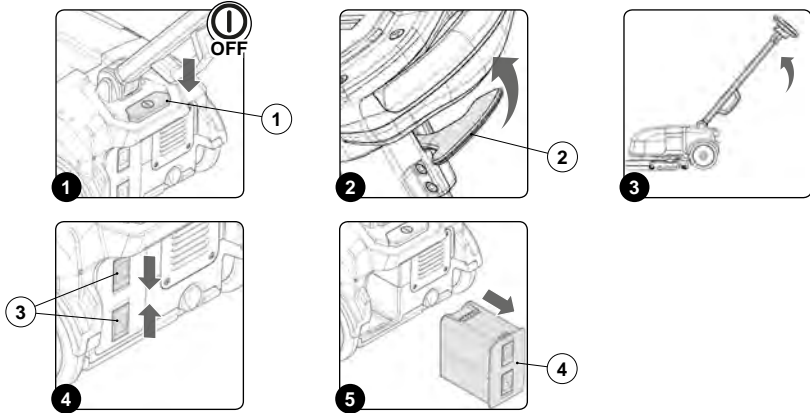

**RECHARGING THE BATTERY**

The battery must be charged prior to the first use, and when it doesn't provide enough power for tasks that could formerly be performed without difficulty. To recharge the battery, proceed as follows:

1. Take the appliance to the dedicated battery recharging area.
2. If the appliance is working, turn it off via the main switch (1) (Fig. 1).
3. Block the handlebar in the vertical position. Push the steering

column control stop lever (2) in the direction indicated by the arrow (Fig.2) and turn the steering column control into the vertical position (Fig.3).

**! ATTENTION:** During this operation, do not rest your foot on the appliance.

4. When the handlebar is in the vertical position, release the stop lever (2) to lock the handlebar.
5. To remove the power battery (4) from the appliance, you must first free it by shifting the stop levers (3) in the direction of the two arrows (Fig. 4). Remove the battery by lifting out of the appliance (Fig. 5).

**! ATTENTION:** The room used to recharge the batteries must be adequately ventilated to prevent the accumulation of gases that leak from batteries.

6. Connect the plug (5) on the battery charger power cable into the socket (6) in the base of the charger (Fig.6).

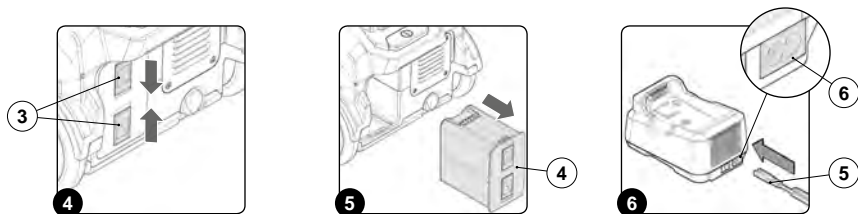



7. Connect the battery charger power supply cable plug to the mains socket.

**! WARNING:** Before connecting to the plug to the socket, check that the characteristics of the mains power supply corresponds to that of the battery charger.

8. Position the main switch (7), on the base of the battery charger, to position "I" (Fig.7).

**! WARNING:** Check that, when giving continuity to the circuit of the battery charger, the green LED (8) present on the battery charger (Fig.8) turns on. This LED indicates that the battery charger circuit is correctly powered.

**! ATTENTION:** Before inserting the battery into the charging holder, check that there is no condensation or other liquid in the dock that will hold the battery.

9. Insert the battery (4) in the seat (9) in the battery charger, taking care to position the poles (10) in the battery correctly (Fig. 9).

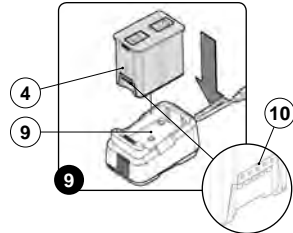
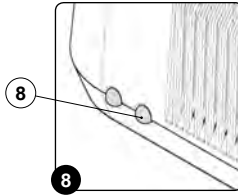
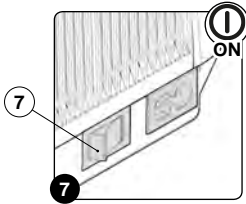

**! ATTENTION:** The battery can only be inserted into the charger one way. Do not use force when inserting the battery.

**! ATTENTION:** Carefully read the battery charger use and maintenance manual delivered with the appliance, before charging the battery.

**! ATTENTION:** Check that, when inserting the battery into the base of the battery charger, the red LED (11) present on the battery charger (Fig.10) turns on. This LED indicates that the battery is recharging.

**! WARNING:** The red charge status LED (11) does not provide any indication of the battery charge level.

**! WARNING:** The battery may overheat during the charging phase, nevertheless, this is normal and does not imply that there is a problem with the battery.

**! WARNING:** If the battery used in this device is over-charged, this may present a risk of fire, explosion or chemical burns.

10. Perform a complete battery charging cycle.

11. With charging complete, position the main switch (7), on the base of the battery charger, to position "0" (Fig.11).

12. Disconnect the battery charger power supply cable plug from the mains socket.

**! WARNING:** The red LED (11) remains on until the battery is fully charged.

**! ATTENTION:** To prevent damaging the power cable, disconnect the plug from the mains socket by directly pulling the plug and not the cable.

**! WARNING:** The charger and the battery can be left connected to the power outlet. The red LED (11) lights when the charger occasionally recharges the battery.

13. Remove the battery (4) from the base of the charger, remove the battery from the body of device upwards (Fig.12).

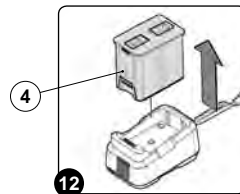
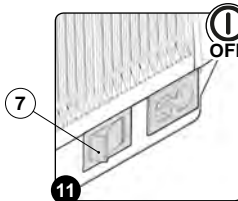
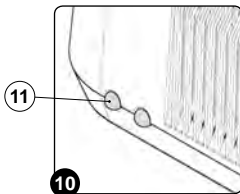

**CONTROL HANDLEBAR ADJUSTMENT**

Correct adjustment of the control handlebar guarantees comfortable use of the appliance. To adjust the control handlebar, proceed as follows:

1. If the appliance is working, turn it off via the main switch (1) (Fig. 1).
2. Unblock the handlebar from the vertical position. Push the steering column control stop lever (2) in the direction indicated by the arrow (Fig.2) and turn the steering column control towards you (Fig.3).

**! ATTENTION:** During this operation, do not rest your foot on the appliance.

3. Turn the steering column control towards you until you find the right position that allows you to operate the appliance comfortably.
4. Once the ideal position has been found, release the steering column control stop lever (2) to lock the handlebar in position.

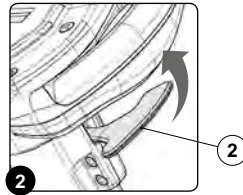
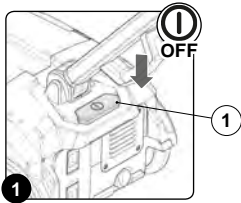

**BATTERY CHARGE LEVEL INDICATOR**

On the instrument panel of the machine there is a monitor indicating (amongst other things) the battery charge status (B). The level of battery charge is indicated via two symbols:

The percentage of charge: The numerical value which precedes the % symbol

The graphic symbol: a line of luminous markings, each bar corresponds to a % of the charge.

If the charge level reaches a certain value, the brush motor will switch off automatically but you can still complete the drying operation.

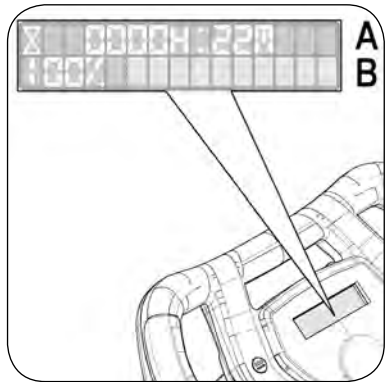

**HOURLY METER**

On the machine's instrument panel there is a display indicating the partial machine usage time (A). The top line shows the hours and minutes of functioning.

If you push the dead man's lever, the hourglass symbol will begin to flash and the appliance will begin to record the machine operation time.

**! ATTENTION:** the flashing of the hourglass symbol is the only sign that the hour meter is counting the machine operation time.

**FILLING THE SOLUTION TANK**

Proceed as follows to fill the solution tank with water:

1. Take the machine to the usual place for filling the solution tank.
2. Do what is required to make sure the machine is in a safe condition (see "MACHINE SAFETY").
3. Disconnect the tank stop levers (1), and rotate in the direction

indicated by the arrow (Fig.1).

4. Remove the recovery tank from the appliance using the handles (2). Gently lay the tank on the ground (Fig.2).

5. Remove the solution tank from the appliance using the handles (3). Gently lay the tank on the ground (Fig.3).

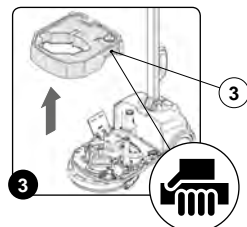
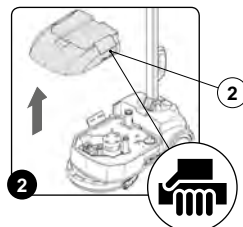
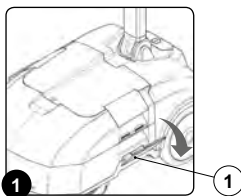

6. Check that the solution tank drainage cap (4) is positioned correctly; if not, rectify this (Fig.4).
7. Remove the detergent solution filling cap (5) from its seat, on the solution tank (Fig.5).
8. Fill with clean water, at a temperature not higher than 50 °C and not lower than 10°C.

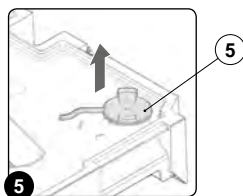
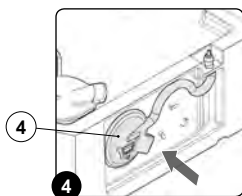

9. Fill with detergent solution (read paragraph on "DETERGENT SOLUTION").
10. Insert the detergent solution filling cap (5) into its seat on the solution tank (Fig.6).
11. Insert the solution tank into the appliance, taking care not to damage the vacuum hose inlet (6) on the vacuum motor, and the squeegee body vacuum hose (7). When positioning the tank, use the handles (3) on the solution tank to help (Fig.7 and Fig.8).

**ATTENTION:** it is good practice to empty the recovery tank every time you top up the solution tank level.

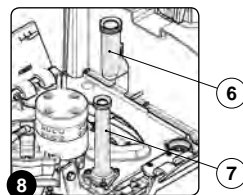
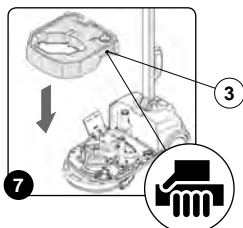
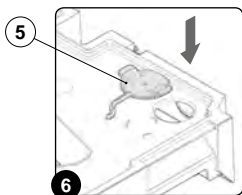

12. Place the recovery tank above the solution tank into the appliance, taking care not to damage the vacuum hose inlet (6) on the vacuum motor, and the squeegee body vacuum hose (7). When positioning the tank, use the handles (3) on the solution tank to help (Fig.9 and Fig.10).

**ATTENTION:** Before placing the recovery tank in position, check that the drainage cap is correctly in place; if not, rectify this.

13. Fix the tanks to the body of the appliance using the tank stop levers (1), turning these in the direction indicated by the arrow (Fig.11).

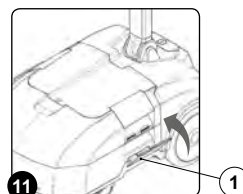
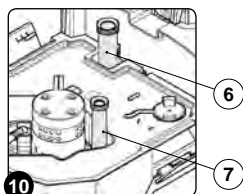
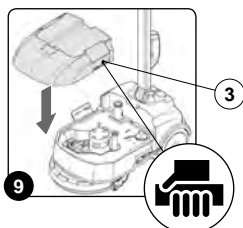

### DETERGENT SOLUTION

Add the liquid detergent to the solution tank in the concentration and manner indicated on the detergent manufacturer's label.

and do not contain oxidising agents, chlorine or bromine, formaldehyde, mineral solvents.

**⚠ ATTENTION:** The formation of excess foam could damage the vacuum motor, so use only the minimum amount of detergent that is necessary.

**⚠ ATTENTION:** protective gloves should always be worn before handling detergents or acidic or alkaline solutions, to avoid serious injury to the hands.

**⚠ ATTENTION:** Always use detergents whose manufacturer's label indicates their suitability for scrubbing machines. Do not use acid or alkaline products or solvents without this indication. Acid or alkaline maintenance detergents can be used, as long as they have pH values between four and ten,

**⚠ ATTENTION:** always use low-foam detergent. To avoid the production of foam, put a minimum quantity of antifoam liquid in the recovery tank before starting to clean. Do not use pure acids.

### INSERTING THE BRUSH INTO THE APPLIANCE

To insert the brush or the pad holder into the brush head unit, proceed as follows:

1. Take the appliance to its designated maintenance area.
2. Take all necessary steps to ensure that the device is in a safe condition (see "[MACHINE SAFETY](#)").

3. Block the handlebar in the horizontal position. Push the steering column control stop lever (1) in the direction indicated by the arrow (**Fig.1**) and turn the steering column control into the horizontal position (**Fig.2**).

**⚠ ATTENTION:** during this process, keep the control handlebar still, in order to prevent the appliance from moving accidentally.



The appliance must not be transported or parked in its idle position when the solution tank and recovery tank are full.

**⚠ ATTENTION:** during this process, keep the control handlebar still, in order to prevent the appliance from moving accidentally.

4. When the handlebar is in the horizontal position, release the stop lever (1) to lock the handlebar (**Fig. 3**).
5. Position the appliance with the rear part in contact with the floor (**Fig.5**), using the handle (2) on the front of the appliance and the handle (3) for assistance (**Fig.4**).
6. Insert the brush (4) onto the fixing pin (5) on the appliance. Push the brush until the tank is in contact with the flange (6) on the appliance (**Fig.6**).

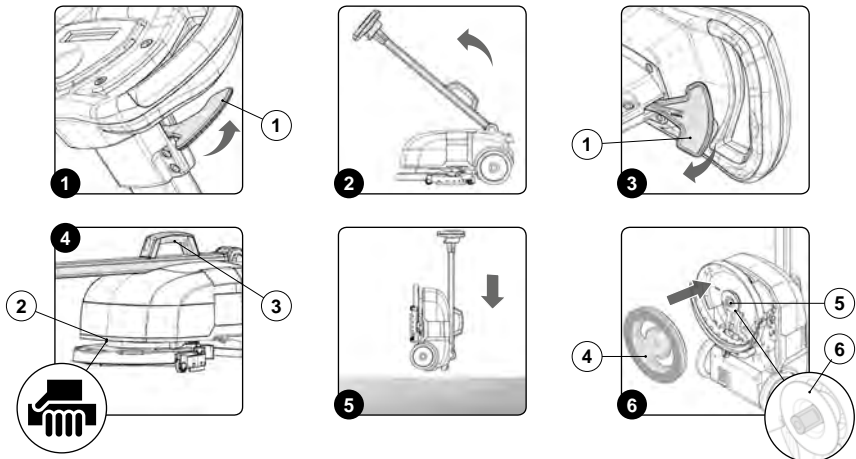

### PREPARING TO WORK

Before beginning to work, it is necessary to:

**⚠ ATTENTION:** Before commencing the first working cycle, charge the battery fully; read the usage instructions for the battery charger provided with the appliance.

1. Before using the appliance, make sure it is in a good, safe working condition. If everything is not in order, the appliance must not be used.

2. Take all necessary steps to ensure that the device is in a safe condition (see "[MACHINE SAFETY](#)").

3. Check that the squeegee rubber blades are suited to the work to be carried out; if not, ensure that maintenance is carried out on these (read paragraph "[CHECKING AND CLEANING SQUEEGEE BODY](#)").

4. Check that the condition of the brush is suitable for the work to be carried out; if not, ensure that maintenance is carried out this component (read paragraph "[CHECKING AND CLEANING THE BRUSH](#)").

- Verify that the quantity of detergent solution in the solution tank is suitable for the type of work you wish to carry out, otherwise fill the solution tank (see the paragraph "[FILLING THE SOLUTION TANK](#)").
- Insert the battery into the battery holder compartment (read paragraph "[INSERTING THE BATTERY INTO THE APPLIANCE](#)").

## WORK

### STARTING WORK

Before beginning to work, it is necessary to:

- Carry out the operations described in the "[PREPARING TO WORK](#)" chapter.
- Check that the squeegee body is in contact with the surface to be cleaned; if not, turn the knob (1) anticlockwise (**Fig.1**).
- Activate the appliance using the main switch (2) (**Fig.2**). The display on the control panel will come on.

- Unblock the handlebar from the vertical position. Push the steering column control stop lever (3) in the direction indicated by the arrow (**Fig.3**) and turn the steering column control towards you.



**ATTENTION:** During this operation, do not rest your foot on the appliance.

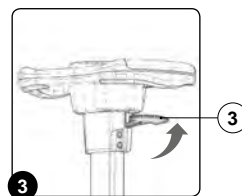
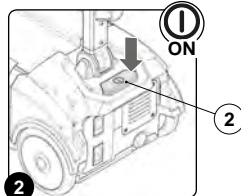
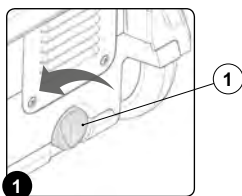

- Adjust the control handlebar (read paragraph "[CONTROL HANDLEBAR ADJUSTMENT](#)").
- Select the quantity of detergent solution to be supplied to the brush.

- When you push the dead man's lever (4), the appliance will begin to move (**Fig.4**).
- If the "AUTOMATIC ECO-MODE" working program is selected, as soon as the dead man's lever is pushed the brush head motor and the vacuum motor will start working, and as a result the pump will also start working and detergent solution will be delivered to the brush.
- During the first metres, check there is sufficient solution and that the squeegee dries perfectly. The appliance will now begin to work with full efficiency until the battery is flat or until the detergent solution runs out.



**ATTENTION:** For correct detergent solution delivery to the brush, only use the button designed for this purpose to deliver solution. Refer to paragraph "[REGULATING THE DETERGENT](#)".

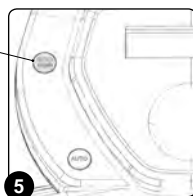
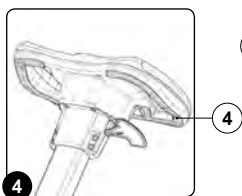

- If you need to increase the degree of cleaning energy of the appliance whilst working, proceed as follows:

- Release the dead man's lever.
- Press the "ECO-MODE" button (5) (**Fig.5**).

- Lift the brush from the floor, pushing the control handlebar downwards. This will rotate the squeegee to the front of the appliance.
- As soon as the squeegee is positioned at the front of the appliance, bring the brush back into contact with the floor.
- Carry out the drying process by moving the appliance towards you.



**ATTENTION:** the "ECO" symbol will disappear from the display, and only the "A" symbol will remain (in the lower right part).

- Resume the work by pushing the dead man's lever.



**ATTENTION:** To bring the squeegee behind the brush, just move forwards slightly then steer in an arc towards the left side of the appliance.

- If you need to dry the floor, bring the appliance towards you and carry out the following steps:

**“PRE-WASH” WORKING PROGRAM**

If you need to perform a pre-wash working program without drying, proceed as follows:

1. If the appliance is working, turn it off via the main switch (1) (Fig. 1).
2. Bring the squeegee to its idle position (Fig.2) (at the centre of

the machine; behind the brush and beneath the main part of the machine).

3. With your hand, lift the squeegee up from the floor (Fig.3) and lock it in this position by pressing the knob (2) and rotating it clockwise by a quarter turn (Fig.4).

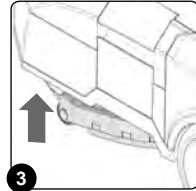
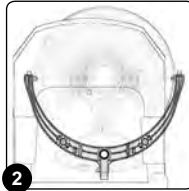
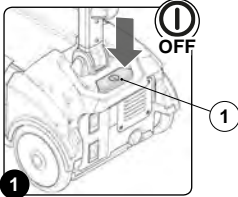

**ATTENTION:** protective gloves should always be worn before handling detergents or acidic or alkaline solutions, to avoid serious injury to the hands.

**ATTENTION:** Make sure the opening (3) on the squeegee support is positioned near the pin (4) (Fig.5).

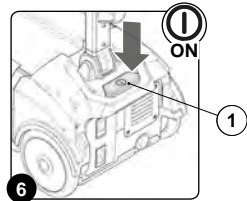
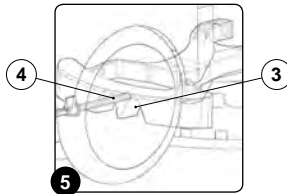
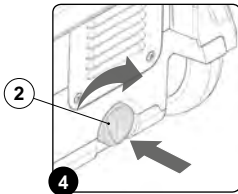

4. Activate the appliance using the main switch (1) (Fig.6).
5. By pressing on the dead man's lever the appliance starts to work.
6. Press the "VACUUM MOTOR ON-OFF" button (5) on the control panel (Fig.7); after about 15 seconds, the vacuum motor will stop working. On the bottom right of the control display, the "O" symbol will appear (Fig.8).
7. The appliance will now work efficiently, dispensing the detergent solution and cleaning the floor, until the battery runs down.
8. During the first few meters, check that the amount of detergent solution being supplied is appropriate to the work to be carried out; if not, adjust after reading the section "REGULATING THE DETERGENT".

If only the pre-wash function is needed (without detergent solution), simply press and hold the button (6) on the control panel (Fig.7); the detergent solution pump will stop working and the supply to the brushes will cease. When the delivery of the detergent solution is suspended, a horizontal line will appear on the control display, in place of the rectangles (Fig.10).

Once the scrubbing cycle without detergent solution is complete, to dispense cleaning solution again press the button (6), to adjust the amount (read paragraph on "REGULATING THE DETERGENT").

**ATTENTION:** If the dead man's lever is released during the work, the appliance will cease to function. To start work again, simply push the dead man's lever.

**ATTENTION:** To bring the squeegee back into contact with the surface to be cleaned while the machine is switched off, simply rotate the knob (2) anticlockwise (Fig.9).

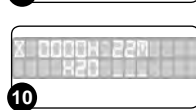
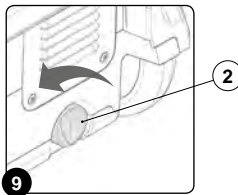
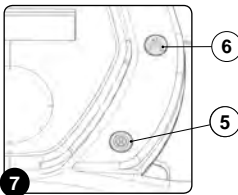

## REGULATING THE DETERGENT

To regulate the detergent, proceed as follows:

1. Verify that the quantity of detergent solution in the solution tank is suitable for the type of work you wish to carry out, otherwise fill the solution tank (see the paragraph "FILLING THE SOLUTION TANK").
2. Check that the brush head is resting on the floor.
3. Activate the appliance using the main switch (1) (Fig.1).
4. By pressing on the dead man's lever the appliance starts to work.
5. During the first few metres, press the pump command button (2) to regulate the flow of detergent onto the brush (Fig.2).

By pressing the button (2) on the control display (Fig.2), a horizontal line will appear. This line is made up of three positions (Fig.3) and, as you continue to press the button, small rectangles will appear. There are three possible adjustments which can be made to the detergent solution flow.

If the display only shows the horizontal line, no detergent solution is being released (Fig.4). This mode is used when the floor is already wet or in general when the chemical action of water and detergent solution is not necessary.

For each press of the button (2), the quantity of solution released will increase by one level. The quantity of solution released can be set to three successive levels. Once the maximum level has been reached (Fig.3), a further press on the button will return you to level 0 (no detergent solution).

**⚠ ATTENTION:** *Passing from one step to another is a continuous cycle - it is not possible to go back except by continuing to the end of the scale and starting again from zero.*

**⚠ ATTENTION:** *By holding down the button (2), the pump flow is brought back to zero (Fig.4).*

**⚠ ATTENTION:** *If the machine is switched off via the main switch, the flow of detergent will return to step-01.*

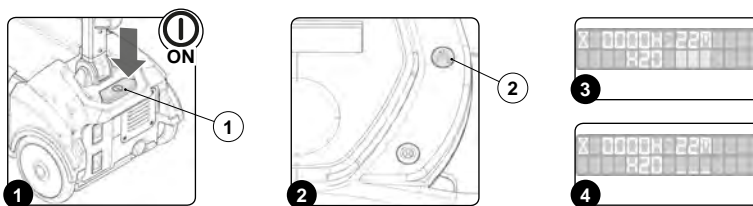

## OVERFLOW DEVICE

The appliance is **NOT** equipped with an overflow device, because the volume of the recovery tank is greater than the capacity of the solution tank. In extraordinary cases, there is a mechanical device (float) beneath the vacuum lid that, when the recovery tank is full, shuts off the air to the vacuum motor intake to protect it; the sound of the vacuum motor will then be deeper.

If this is the case, proceed as follows:

1. Release the dead man's lever (1) (Fig.1) to disable the brush motor and the pump. The vacuum motor will also stop working after a determined lapse of time.
2. As soon as the vacuum motor switches off, de-activate the device, using the main switch (2) (Fig.2).
3. Lift the squeegee from the floor.
4. Lock the control handlebar, push the steering column control stop lever (3) in the direction indicated by the arrow (Fig.3).



The appliance must not be transported or parked in its idle position when the solution tank and recovery tank are full.

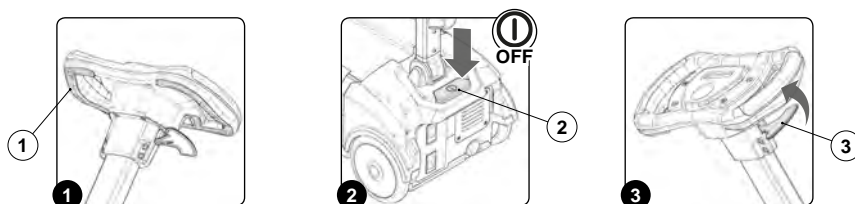

5. Turn the control steering column to the vertical position (Fig.4).

**! ATTENTION:** During this operation, do not rest your foot on the appliance.

6. When the handlebar is in the vertical position, release the stop lever (3) to lock the handlebar (Fig. 5).

7. Tilt the machine and move the unit into a suitable place for discharging waste water. Empty the recovery tank (refer to "CHECKING AND CLEANING THE RECOVERY TANK") (Fig. 6).

**! ATTENTION:** The place this operation is carried out should comply with current environmental protection regulations.

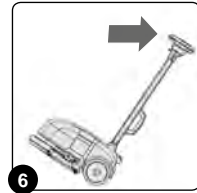
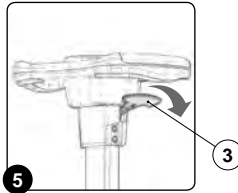
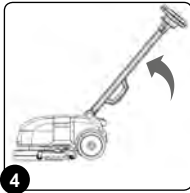

**AT THE END OF THE WORK**

At the end of the work, and before carrying out any type of maintenance, perform the following operations:

1. Release the dead man's lever (1) (Fig.1) to disable the brush motor and the pump. The vacuum motor will also stop working after a determined lapse of time.
2. As soon as the vacuum motor switches off, de-activate the device, using the main switch (2) (Fig.2).
3. Lift the squeegee from the floor.
4. Lock the control handlebar, push the steering column control stop lever (3) in the direction indicated by the arrow (Fig.3).
5. Turn the control steering column to the vertical position (Fig.4).

**! ATTENTION:** The appliance must not be transported or parked in its idle position when the solution tank and recovery tank are full.

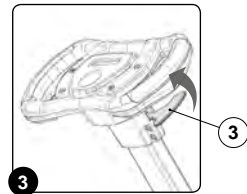
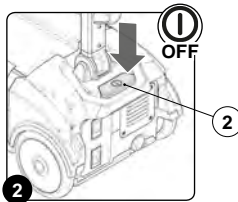
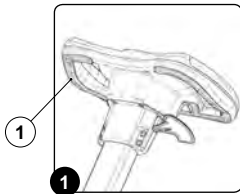

**! ATTENTION:** During this operation, do not rest your foot on the appliance.

6. When the handlebar is in the vertical position, release the stop lever (3) to lock the handlebar (Fig. 5).

7. Tilt the machine and move to a suitable place for carrying out maintenance work (Fig.6), then complete the procedures listed in the paragraph "RECOMMENDED PERIODIC MAINTENANCE OPERATIONS" in the columns "AT THE END OF THE WORK".

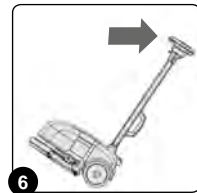
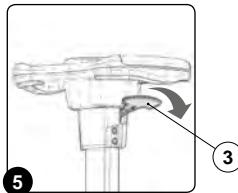
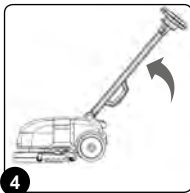



8. Once the maintenance operations are complete, take the appliance to the designated storage area.
9. Block the handlebar in the horizontal position. Push the steering column stop lever (3) in the direction indicated by the arrow (Fig.7) and turn the steering column control into the horizontal position (Fig.8).
10. When the handlebar is in the horizontal position, release the stop lever (3) to lock the handlebar.
11. Position the appliance with its rear part in contact with the floor (Fig.9).

**⚠ ATTENTION:** During this operation, do not rest your foot on the appliance.

**⚠ ATTENTION:** Park the machine in an enclosed place, on a flat surface; near the machine there must be no objects that could either damage it, or be damaged through contact with it.

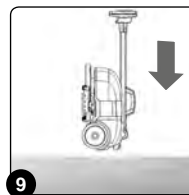
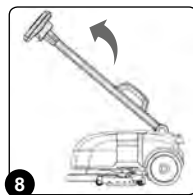
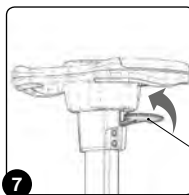

## MAINTENANCE

### RECOMMENDED MAINTENANCE OPERATIONS

TYPE OF MAINTENANCE	AT THE END OF THE WORK	DAILY	WEEKLY	BEFORE A LONG PERIOD OF NON-USE	TRANSPORT
Checking and cleaning the recovery tank	X	X		X	X
Charging the battery (1)		X			
Checking and cleaning the vacuum cover		X		X	
Checking and cleaning the brush		X		X	
Checking and cleaning the squeegee		X		X	
Cleaning the vacuum hose		X		X	
Checking and cleaning the detergent solution filter			X	X	
Checking and cleaning the solution tank			X	X	X

Note: (1) Check the level of charge during work

**CHECKING AND CLEANING THE RECOVERY TANK**

Proceed as follows to empty the recovery tank:

1. Take the appliance to the dedicated waste water drainage area.
2. Take all necessary steps to ensure that the device is in a safe condition (see "MACHINE SAFETY").
3. Disconnect the tank stop levers (1), and rotate in the direction indicated by the arrow (Fig.1).
4. Remove the recovery tank using the handles (2) present on the tank (Fig.2). Gently place on the floor.
5. Disconnect the vacuum cover stop levers (3), and rotate in the direction indicated by the arrow (Fig.3).

**! ATTENTION:** The place this operation is carried out should comply with current environmental protection regulations.

**! ATTENTION:** Users are advised to always wear protective gloves, to avoid the risk of serious injury to hands.

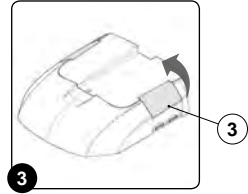
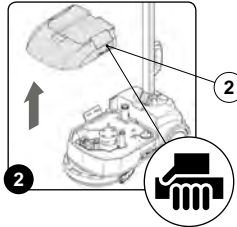
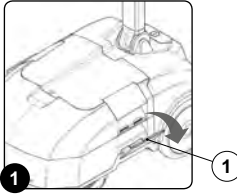

6. Remove the vacuum cover using the stop levers. Gently lay on the ground (Fig.4).
7. Emptying the tank (Fig.5).
8. Remove the drainage cap (4) from the hole on the rear of the tank (Fig.6) and empty the tank completely.
9. Rinse the inside with a jet of water, if necessary use a spatula to remove the sludge that has accumulated at the bottom of the tank.

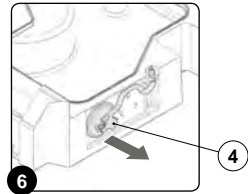
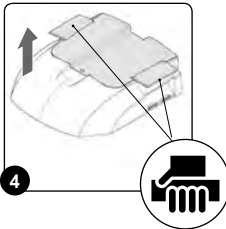

10. Replace the drainage cap on the rear of the tank (4).
11. Place the recovery tank above the solution tank into the appliance, taking care not to damage the vacuum hose inlet (5) on the vacuum motor, and the squeegee body vacuum hose (6). When positioning the tank, use the handles (2) on the solution tank to help (Fig.7 and Fig.8).

**! ATTENTION:** Before placing the recovery tank in position, check that the drainage cap (4) is correctly in place; if not, rectify this.

12. Fix the tanks to the body of the appliance using the tank stop levers (1), turning these in the direction indicated by the arrow (Fig.9).

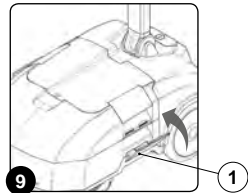
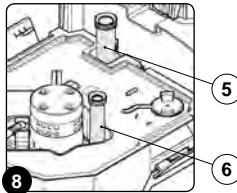
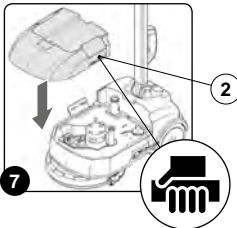

### CHECKING AND CLEANING THE VACUUM COVER

The careful cleaning of the vacuum cover floats guarantees a longer appliance life span. Proceed as follows to clean the vacuum cover:

1. Take the appliance to the dedicated waste water drainage area.

**! ATTENTION:** *The place this operation is carried out should comply with current environmental protection regulations.*

2. Take all necessary steps to ensure that the device is in a safe condition (see "MACHINE SAFETY").

3. Disconnect the vacuum cover stop levers (1), and rotate in the direction indicated by the arrow (Fig.1).

4. Remove the vacuum cover using the stop levers (Fig.2).

**! ATTENTION:** *Users are advised to always wear protective gloves, to avoid the risk of serious injury to hands.*

5. First with a jet of water and then with a damp cloth, thoroughly clean the rotation fulcrum (2) on the vacuum motor floats (Fig.3).

6. First with a jet of water and then with a damp cloth, thoroughly clean the central floats (3) (Fig.4).

7. First with a jet of water and then with a damp cloth, thoroughly clean the side floats (4) (Fig.4).

8. Clean the dirty water conveyor compartment with a jet of water; the entrance hole to this compartment is identified by the letter (A), while the outlet is identified with the letter (B) (Fig. 5).

9. Clean the vacuum motor air conveyor compartment with a jet of air; the entrance hole to this compartment is identified by the letter (C), while the outlet is identified with the letter (D) (Fig. 6).

10. Repeat the operations in reverse order to reassemble all the parts.

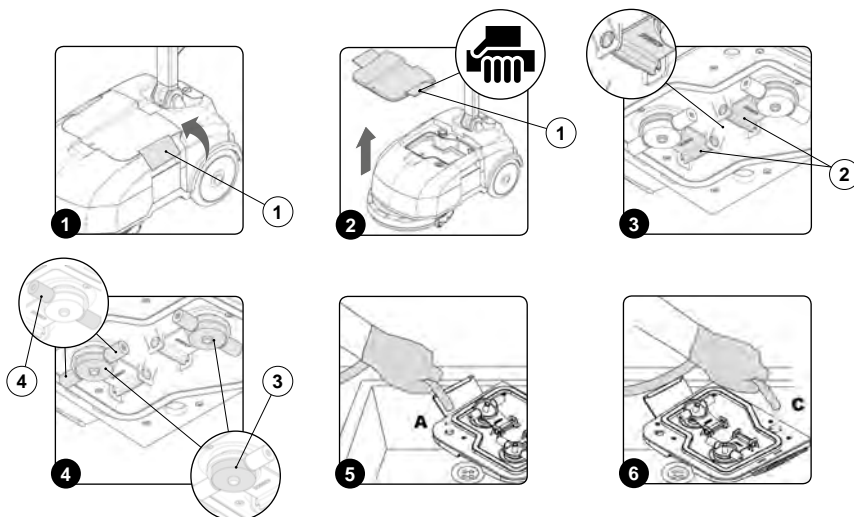

**CHECKING AND CLEANING THE BRUSH**

Careful cleaning of the brushes guarantees better cleaning of the floor as well as a longer brush motor life. To clean the brushes, proceed as follows:

1. Take the appliance to its designated maintenance area.
2. Take all necessary steps to ensure that the device is in a safe condition (see "MACHINE SAFETY").
3. Block the handlebar in the horizontal position. Push the steering column control stop lever (1) in the direction indicated by the arrow (Fig.1) and turn the steering column control into the horizontal position (Fig.2).
4. When the handlebar is in the horizontal position, release the stop lever (1) to lock the handlebar (Fig. 3).

 The appliance must not be transported or parked in its idle position when the solution tank and recovery tank are full.

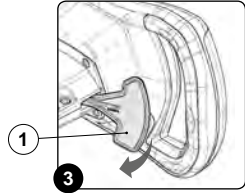
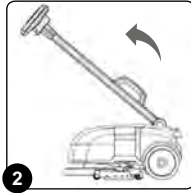
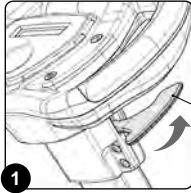

5. Position the appliance with the rear part in contact with the floor (Fig.5), using the handle (2) on the front of the appliance and the handle (3) for assistance (Fig.4).
6. Remove the brush from the appliance (Fig.6).
7. Clean the brush under running water to remove any impurities present in the bristles of the brush. Check that the bristles are not worn; in the event of excessive wear replace the brush (the bristles should be at least 10 mm long).

8. Repeat the operations in reverse order to reassemble all the parts.

 **ATTENTION:** during this process, keep the control handlebar still, in order to prevent the appliance from moving accidentally.

 **WARNING:** Users are advised to always wear protective gloves, to avoid the risk of serious injury to hands.

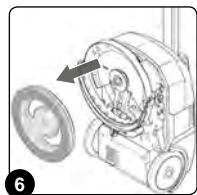
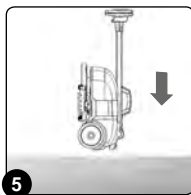
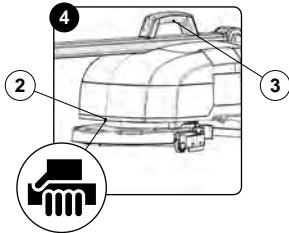

**CHECKING AND CLEANING THE SQUEEGEE BODY**

The careful cleaning of the whole vacuum unit ensures better drying and cleaning of the floor as well as a longer vacuum motor life. To carry out the cleaning of the squeegee unit, proceed as follows:

1. Take the device to the dedicated maintenance area.
2. Take all necessary steps to ensure that the device is in a safe condition (see "MACHINE SAFETY").
3. Rotate the squeegee attachment (1) until it is at the front of the appliance (Fig.1).

 **ATTENTION:** Users are advised to always wear protective gloves, to avoid the risk of serious injury to hands.

4. Remove the vacuum hose (2) from the vacuum nozzle on the squeegee body (Fig.2).
5. Turn the wing nuts (3) by ninety degrees (Fig.3).

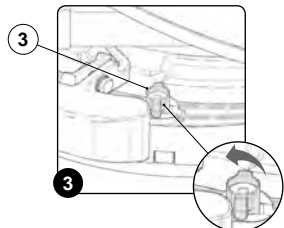
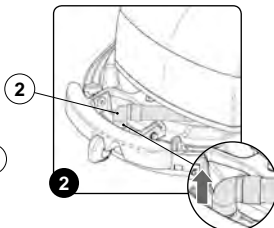
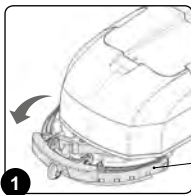

6. Lift the squeegee attachment (1) (Fig.4).
7. Remove the squeegee from the slots on the squeegee connector (4), taking care not to lose the seal (5) on the vacuum nozzle (Fig.5).
8. First with a jet of water and then with a damp cloth, thoroughly clean the vacuum nozzle chamber (6) (Fig.6).
9. First with a jet of water and then with a damp cloth, thoroughly clean the squeegee body vacuum chamber (7) (Fig.7).
10. First with a jet of water and then with a damp cloth, thoroughly clean the front (8) and rear (9) rubber blades of the squeegee body (Fig.9).

11. Check the wear of the front rubber blade (8) on the squeegee body; if the edge of the rubber in contact with the floor is worn, replace it, however the rubber can be turned onto another of its 4 edges (Fig.9).
12. Check the wear of the rear rubber blade (9) on the squeegee body; if the edge of the rubber in contact with the floor is worn, replace it, however the rubber can be turned onto another of its 4 edges (Fig.10).
13. Repeat the operations in reverse order to reassemble all the parts.

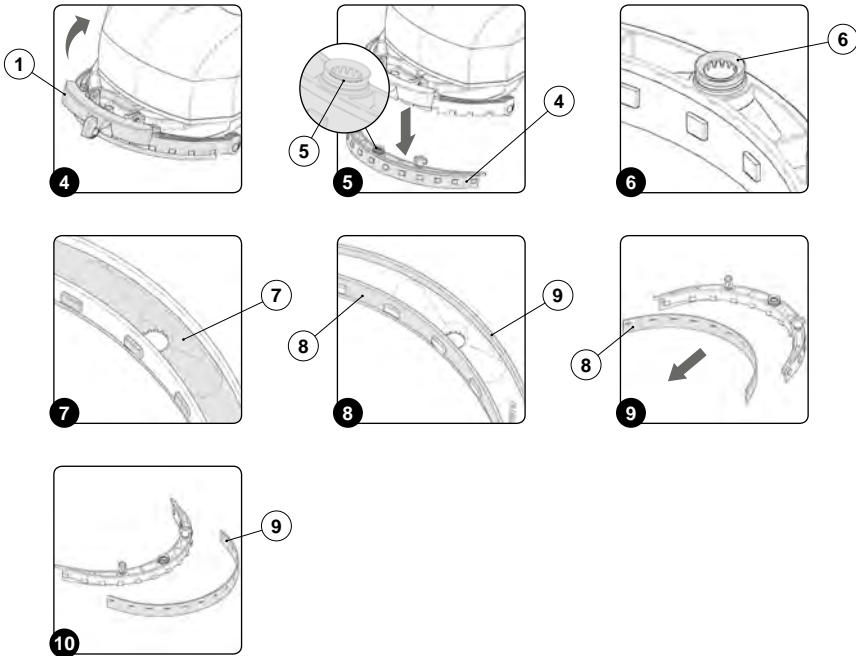

### CHECKING AND CLEANING THE VACUUM HOSE

The careful cleaning of the squeegee body vacuum hose guarantees a longer appliance life span. Proceed as follows to clean the squeegee body vacuum hose:

1. Take the device to the dedicated maintenance area.



**ATTENTION:** The place this operation is carried out should comply with current environmental protection regulations.

2. Take all necessary steps to ensure that the device is in a safe condition (see "MACHINE SAFETY").

3. Disconnect the tank stop levers (1), and rotate in the direction indicated by the arrow (Fig.1).
4. Remove the tanks using the handles (2) present on the solution tank (Fig.2). Gently place on the floor.
5. Clean the inside of the squeegee vacuum hose (3) with a jet of running water, inserting the hose into the nozzle as indicated by the arrow (Fig.3).
6. Repeat the operations in reverse order to reassemble all the parts.

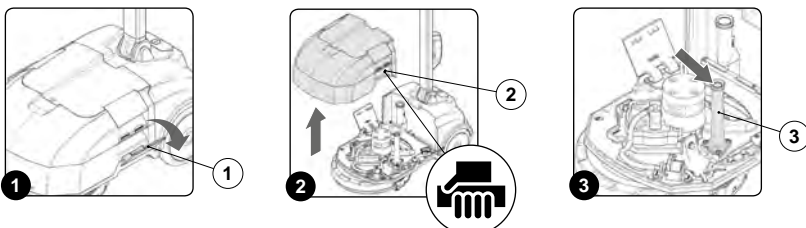

**CHECKING AND CLEANING THE SOLUTION FILTER**

The careful cleaning of the detergent solution filter guarantees a longer appliance life span. Proceed as follows to clean the detergent solution filter:

1. Take the device to the dedicated maintenance area.

**! ATTENTION:** *The place this operation is carried out should comply with current environmental protection regulations.*

2. Take all necessary steps to ensure that the device is in a safe condition (see "[MACHINE SAFETY](#)").

3. Disconnect the tank stop levers (1), and rotate in the direction indicated by the arrow (Fig.1).
4. Remove the tanks using the handles (2) present on the solution tank (Fig.2). Gently place on the floor.
5. Remove the filter cartridge (3) and clean it under a jet of water, remove any dirt that might be attached. If necessary, replace (Fig.3).
6. Repeat the operations in reverse order to reassemble all the parts.

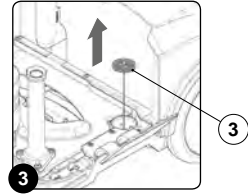
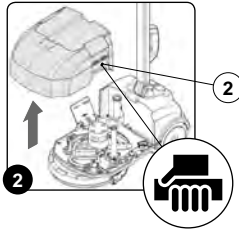
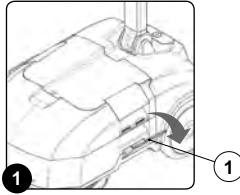

**CHECKING AND CLEANING THE SOLUTION TANK**

The careful cleaning of the solution tank guarantees a longer appliance life span.

1. Take the machine to the usual place for filling the solution tank.
2. Do what is required to make sure the machine is in a safe condition (see "[MACHINE SAFETY](#)").
3. Disconnect the tank stop levers (1), and rotate in the direction

- indicated by the arrow (Fig.1).
4. Remove the recovery tank from the appliance using the handles (2) (Fig.2). Gently place on the floor.
5. Remove the solution tank from the appliance using the handles (3) (Fig.3). Gently place on the floor.

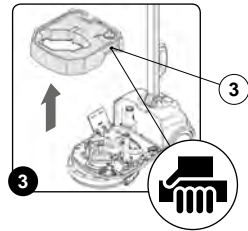
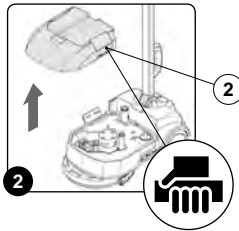
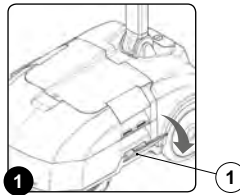

1. Check that the solution tank drainage cap (4) is positioned correctly; if not, rectify this (Fig.4).
2. Remove the detergent solution filling cap (5) from its seat, on the solution tank (Fig.5).
3. Empty the solution tank and rinse with a jet of water.

4. Remove the drainage cap (4) from the hole on the rear of the tank (Fig.6) and empty the tank completely.
5. Rinse the inside with a jet of water, if necessary use a spatula to remove the sludge that has accumulated at the bottom of the tank.

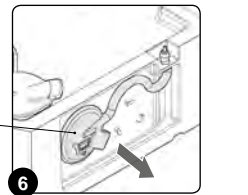
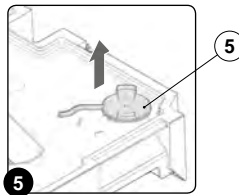
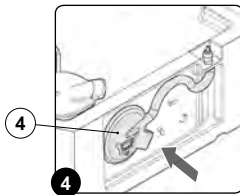

6. Insert the detergent solution drainage cap (4) into its seat on rear part of the solution tank (Fig.7).
7. Insert the detergent solution filling cap (5) into its seat on the solution tank (Fig.8).

**! ATTENTION:** *it is good practice to empty the recovery tank every time you top up the solution tank level.*

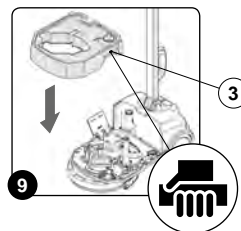
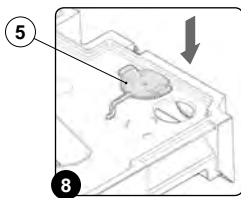
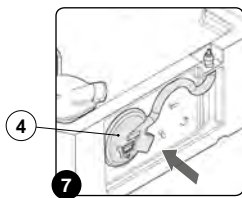

8. Insert the solution tank into the appliance, taking care not to damage the vacuum hose inlet (6) on the vacuum motor, and the squeegee body vacuum hose (7). When positioning the tank, use the handles (3) on the solution tank to help (Fig.9 and Fig.10).

**! ATTENTION:** Before placing the recovery tank in position, check that the drainage cap is correctly in place; if not, rectify this.

9. Place the recovery tank above the solution tank into the appliance, taking care not to damage the vacuum hose inlet (6) on the vacuum motor, and the squeegee body vacuum hose (7). When positioning the tank, use the handles (9) on the solution tank to help (Fig.11 and Fig.12).

10. Fix the tanks to the body of the appliance using the tank stop levers (1), turning these in the direction indicated by the arrow (Fig.13).

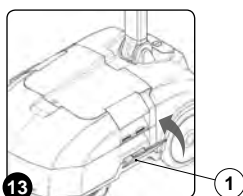
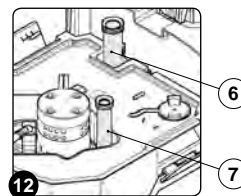
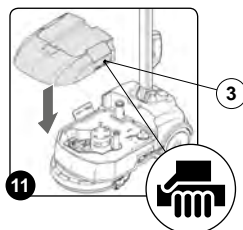
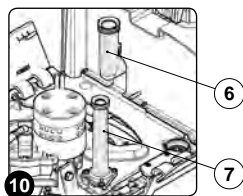

## TROUBLESHOOTING

This chapter lists the most common problems linked with the use of the appliance. If you are unable to resolve the problems with the information given here, please contact your nearest assistance centre.

PROBLEM	POSSIBLE CAUSE	SOLUTION
THE APPLIANCE DOES NOT SWITCH ON	The main switch is in the "0" position.	Check that the main switch has been correctly activated, press the main switch.
	Check that no error or alarm messages are displayed on the control screen when appliance is switched on.	Quickly stop the appliance and contact a technician at the dedicated Technical Service Centre.
	Check that the battery is correctly inserted into the appliance.	Insert the battery correctly into the appliance (read paragraph on <a href="#">"INSERTING THE BATTERY INTO THE APPLIANCE"</a> ).
	Check the battery charge level.	If the battery charge level is critical, perform a complete recharge cycle (see paragraph <a href="#">"ACHARGING THE BATTERY"</a> ).
THE BATTERY HAS NOT BEEN CHARGED CORRECTLY	The power supply cable plug is not correctly inserted in the battery charger base socket.	Check that the plug on the battery charger power cable is connected to the socket on the battery charger base.
	The power supply cable plug is not correctly inserted in the mains socket.	Check that the battery charger power supply cable plug is connected to the mains socket.
	The power supply network is not compatible with the battery charger requirements.	Check that the features set out of the battery charger information plate match those of the power supply network.
	The LED on the battery charger base flashes repeatedly.	Referring to the battery charger use and maintenance manual, check the meaning of the flashing signals that the battery charger emits during the battery recharge stage.
THE DEVICE HAS A VERY LOW OPERATING AUTONOMY	Check the battery charge level, check the symbol on the control display.	If the battery charge level is critical, perform a complete recharge cycle (see paragraph <a href="#">"ACHARGING THE BATTERY"</a> ).
NOT ENOUGH DETERGENT SOLUTION ON THE BRUSH	The quantity of detergent solution in the water system is not suited to the work to be carried out.	Check that the quantity of detergent solution in the water system of the appliance is appropriate to the work to be carried out (read the paragraph on <a href="#">"REGULATING THE DETERGENT"</a> ).
	Detergent solution filter blocked.	Check that the detergent solution filter is not obstructed; if this is the case, proceed with cleaning (read the paragraph on <a href="#">"CHECKING AND CLEANING THE SOLUTION FILTER"</a> ).



PROBLEM	POSSIBLE CAUSE	SOLUTION
THE DEVICE DOES NOT CLEAN CORRECTLY	The appliance does not switch on.	Read the section <a href="#">"THE APPLIANCE DOES NOT SWITCH ON"</a> .
	The amount of detergent solution dispensed is inadequate.	Read the section <a href="#">"NOT ENOUGH DETERGENT SOLUTION ON THE BRUSH"</a> .
	The program selected is not appropriate for the work to be carried out.	Check that the selected program is suitable for the work to be carried out (read the chapter on <a href="#">"WORK"</a> ).
	The brush used is not correctly inserted into the appliance.	Check that the brush is correctly inserted into the appliance (read the paragraph on <a href="#">"INSERTING THE BRUSH INTO THE APPLIANCE"</a> ).
	The type of brush is not appropriate for the dirt which needs to be cleaned	Check that the brush fitted onto the appliance is suited to the work to be carried out (read the chapter on <a href="#">"SELECTION AND USE OF BRUSH"</a> ).
	The brush bristles are subject to excessive wear	Check the wear on the brush and replace if necessary (read paragraph on <a href="#">"CHECKING AND CLEANING BRUSH"</a> ).
THE SQUEEGEE DOES NOT DRY PERFECTLY	The vacuum device is obstructed	Make sure that the squeegee is free from obstructions (read paragraph <a href="#">"CHECKING AND CLEANING THE SQUEEGEE BODY"</a> ).
		Make sure that the vacuum hose is free from obstructions (read paragraph <a href="#">"CHECKING AND CLEANING THE VACUUM HOSE"</a> ).
		Make sure that the vacuum cover is free from obstructions (read paragraph <a href="#">"CHECKING AND CLEANING THE VACUUM COVER"</a> ).
	The recovery tank drainage tap is not positioned correctly.	Check that the drainage cap on the recovery tank is properly positioned.
	The vacuum cover is not positioned correctly.	Make sure that the vacuum cover is correctly positioned on the appliance.
EXCESSIVE FOAM PRODUCTION	The detergent being used is not suitable.	Check that a low foam detergent has been used. If necessary, add a small quantity of antifoam liquid to the recovery tank.
	The floor is not very dirty.	Dilute the detergent inside the solution tank.
THE DEVICE DOES NOT VACUUM CORRECTLY	The recovery tank is full	Empty the recovery tank (read the paragraph <a href="#">"CHECKING AND CLEANING THE RECOVERY TANK"</a> ).
	The vacuum device is obstructed	Read the section <a href="#">"THE SQUEEGEE DOES NOT DRY PERFECTLY"</a> .
	The floating support is blocked	Clean the floating support rotation fulcrum (read the paragraph on <a href="#">"CHECKING AND CLEANING THE VACUUM COVER"</a> ).

## DISPOSAL

To dispose of the appliance, take it to a demolition centre or an authorised collection centre.

Before scrapping the appliance, it is necessary to remove and separate out the following materials, then send them to the appropriate collection centres in accordance with applicable environmental hygiene regulations:

- Brushes
- Felt
- Electric and electronic parts\*
- Batteries
- Plastic parts (tanks and handlebars)
- Metal parts (levers and frame)

(\* In particular, contact your distributor when scrapping electric and electronic parts.

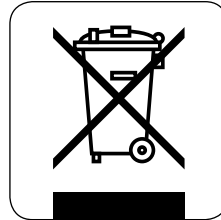

## SELECTION AND USE OF THE BRUSH

### POLYPROPYLENE BRUSH (PPL)

Used on all types of floors. Good resistance to wear and tear, and hot water (no greater than 50°C.). The polypropylene brush is non-hygroscopic and therefore retains its characteristics even when working in wet conditions.

### THICKNESS OF THE BRISTLES

Thicker bristles are more rigid and are therefore used on smooth floors or floors with small joints.

On uneven floors or those with deep joints, it is advisable to use softer bristles which can enter the gaps more easily.

Remember that when the bristles are worn and therefore too short, they will become rigid and are no longer able to penetrate and clean deep down. In this case, like with overlarge bristles, the brush tends to jump.

### PAD HOLDER

The pad holder is recommended for cleaning shiny surfaces.

There are two types of pad holder:

The traditional pad holder is fitted with a series of anchor points that allow the abrasive floor pad to be held and dragged while working.

the CENTRE LOCK type pad holder not only has anchor points, but also a snap-type central locking system in plastic that allows the abrasive floor pad to be perfectly centred and held without any risk of it becoming detached. This type of pad holder is recommended above all for machines with more than one brush, where the centring of the abrasive discs is difficult.

APPLIANCE	No. OF BRUSHES	CODE	TYPE OF BRISTLES	Ø BRISTLES	Ø BRUSHES.	NOTE
Genie XS	1	439929	PPL	0.3	280	PPL brush
	1	439930				Pad holder

## EC DECLARATION OF CONFORMITY



The undersigned manufacturer:

**FIMAP S.p.A.**

Via Invalidi del Lavoro, 1  
37050 Santa Maria di Zevio (VR)

Declares under its sole responsibility that the products

**FLOOR SCRUBBING MACHINE** mod. Genie XS

comply with the requirements of the following Directives:

- 2006/42/EC: Machinery Directive.
- 2004/108/EC: Electromagnetic Compatibility Directive.

They also comply with the following standards:

- EN 60335-1: Household and similar electrical appliances - Safety. Part 1: Generic standards.
- EN 60335-2-72: Safety of household and similar electrical appliances. Part 2: Specific standards for automatic machines for floor treatment for commercial and industrial use.
- EN 12100-1: Machine safety - Fundamental concepts, fundamental principles for design - Part 1: Basic terminology and methodology.

- EN 12100-2: Machine safety - Fundamental concepts, fundamental principles for design - Part 2: Technical principles.
- EN 61000-6-2: Electromagnetic compatibility (EMC) - Part 6-2: Generic standards – Immunity for industrial environments.
- EN 61000-6-3: Electromagnetic compatibility (EMC) - Part 6-3: Generic standards – Standard emission for residential, commercial and light-industrial environments.
- EN 62233: Household and similar electrical appliances - Electromagnetic fields - Methods for evaluation and measurement.

The person authorised to compile the technical file:

Mr. Giancarlo Ruffo  
Via Invalidi del Lavoro, 1  
37059 Santa Maria di Zevio (VR) - ITALY

Santa Maria di Zevio (VR), 07/01/2015

FIMAP S.p.A.  
Legal representative  
Giancarlo Ruffo





FIMAP S.p.A. - Via Invalidi del Lavoro, 1 - 37059 S. Maria di Zevio - Verona - Italy  
Tel. +39 045 6060411 - Fax +39 045 6060417 - E-mail: [fimap@fimap.com](mailto:fimap@fimap.com)  
[www.fimap.com](http://www.fimap.com)