

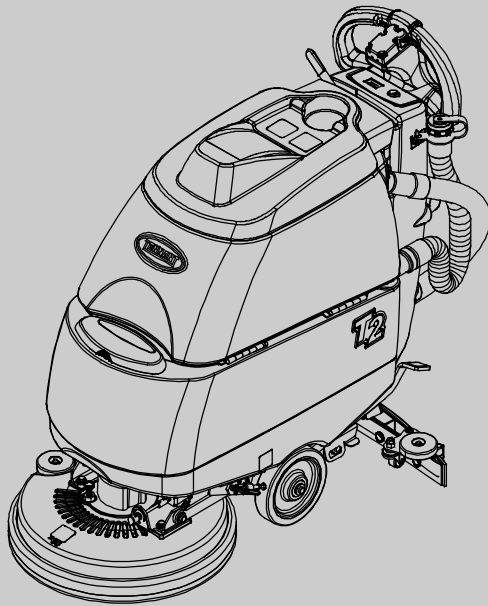

T2

Scrubber-Dryer

English **EN**
Operator Manual



CE

Europe



For the latest Parts manuals and other language Operator manuals, visit:

www.tennantco.com/manuals

9004776
Rev. 02 (07-2016)



This manual is furnished with each new model. It provides necessary operation and maintenance instructions.

Read this manual completely and understand the machine before operating or servicing it.

This machine will provide excellent service. However, the best results will be obtained at minimum costs if:

- The machine is operated with reasonable care.
- The machine is maintained regularly - per the machine maintenance instructions provided.
- The machine is maintained with manufacturer supplied or equivalent parts.

To view, print or download manuals online visit www.tennantco.com/manuals



Parts and supplies may be ordered online, by phone, by fax or by mail.

MACHINE DATA

Please fill out at time of installation for future reference.	
Model No. -	_____
Serial No. -	_____
Machine Options -	_____
Sales Rep. -	_____
Sales Rep. phone no. -	_____
Customer Number -	_____
Installation Date -	_____

TABLE OF CONTENTS

SAFETY PRECAUTIONS	3
SAFETY LABELS	4
MACHINE COMPONENTS	5
MACHINE OPERATION SYMBOLS	5
MACHINE INSTALLATION	6
HOW THE MACHINE WORKS	7
BRUSH AND PAD INFORMATION	7
MACHINE SETUP	7
MACHINE OPERATION	10
DRAINING TANKS	12
CHARGING BATTERIES	13
MACHINE MAINTENANCE	15
TRANSPORTING MACHINE	18
STORING MACHINE	18
TROUBLESHOOTING	19
MACHINE SPECIFICATIONS	20

	PROTECT THE ENVIRONMENT
	

Please dispose of packaging materials, old machine components such as batteries, hazardous fluids such as anti-freeze and oil, in a safe environmental-ly way according to your local waste disposal regulations.

Always remember to recycle.

TENNANT N.V.
Industrielaan 6 5405 AB
P.O. Box 6 5400 AA Uden- The Netherlands

europa@tennantco.com
www.tennantco.com

Specifications and parts are subject to change without notice.

Original instructions, copyright ©2008, 2016 Tennant Company. All rights reserved. Printed in the Netherlands.

SAFETY PRECAUTIONS

This machine is intended for commercial use. It is designed exclusively to scrub hard floors in an indoor environment and is not constructed for any other use.

The following warning alert symbol and the "FOR SAFETY" heading are used throughout this manual as indicated in their description:

⚠ WARNING: To warn of hazards or unsafe practices which could result in severe personal injury or death.

FOR SAFETY: To identify actions which must be followed for safe operation of equipment.

All operators must read, understand and practice the following safety precautions.

The following safety precautions signal potentially dangerous conditions to the operator or equipment.

⚠ WARNING: Fire Or Explosion Hazard:

- Do Not Pick Up Flammable Materials.
- Do Not Use Near Flammable Liquids, Vapors Or Combustible Dusts.
- Only Use Commercially Approved Floor Cleaners Intended for Machine Application.
- Batteries Emit Hydrogen Gas. Keep Sparks And Open Flame Away. Keep Battery Compartment Open When Charging.

⚠ WARNING: Electrical Hazard

- Disconnect Battery Cables and Charger Plug Before Servicing Machine.
- Do Not Charge Batteries with Damaged Power Supply Cord. Do Not Modify Plug.

If the charger supply cord is damaged or broken, it must be replaced by the manufacturer or its service agent or a similarly qualified person in order to avoid a hazard.

⚠ WARNING: Spinning Brush. Keep Hands Away. Turn Off Power Before Working On Machine.

FOR SAFETY:

1. Do not operate machine:

- In an area where flammable liquids/vapors or combustible dusts are present.
- Unless trained and authorized.

- Unless operator manual is read and understood.
- If not in proper operating condition.

2. Before starting machine:

- Make sure all safety devices are in place and operate properly.
- Place wet floor signs as needed.

3. When using machine:

- Go slow on inclines and slippery surfaces.
- Wear non-slip shoes.
- Reduce speed when turning.
- Report machine damage or faulty operation immediately.
- Do not allow children to play on or around machine.
- Follow mixing and handling instructions on chemical containers.
- Do not operate on inclines.

4. Before leaving or servicing machine:

- Stop on level surface.
- Turn off machine.
- Set parking brake if equipped.
- Remove key.

5. When servicing machine:

- Avoid moving parts. Do not wear loose jackets, shirts, or sleeves.
- Disconnect battery connections before working on machine.
- Wear protective gloves and eye protection when handling batteries or battery cables.
- Avoid contact with battery acid.
- Do not power spray or hose off machine. Electrical malfunction may occur.
- Use manufacturer supplied or approved replacement parts.
- All repairs must be performed by a qualified service person.
- Do not modify the machine from its original design.

6. When transporting machine:

- Drain tanks before loading.
- Turn machine off.
- Do not lift machine when batteries are installed.
- Get assistance when lifting machine.
- Use a recommended ramp when loading/unloading into/off truck or trailer.
- Use tie-down straps to secure machine to truck or trailer.
- Put scrub head in the lowered position.
- Set parking brake if equipped.

SAFETY LABELS

The safety labels appear on the machine in the locations indicated. Replace labels if they are missing or become damaged or illegible.



READ MANUAL LABEL -
Located on recovery tank cover.

FOR SAFETY: Do not operate machine unless operation manual is read and understood.



⚠ WARNING: Fire or Explosion Hazard. Do not use flammable liquids. Do not pick flammable liquids



BATTERY CHARGE LABEL -
Located at bottom side of recovery tank.

⚠ WARNING: Fire Or Explosion Hazard. Batteries Emit Hydrogen Gas. Keep Sparks And Open Flame Away. Keep Battery Compartment Open When Charging.



SPINNING BRUSH LABEL -
Located on scrub head

⚠ WARNING: Spinning Brush. Keep Hands Away. Turn Off Power Before Working On Machine.

MACHINE COMPONENTS

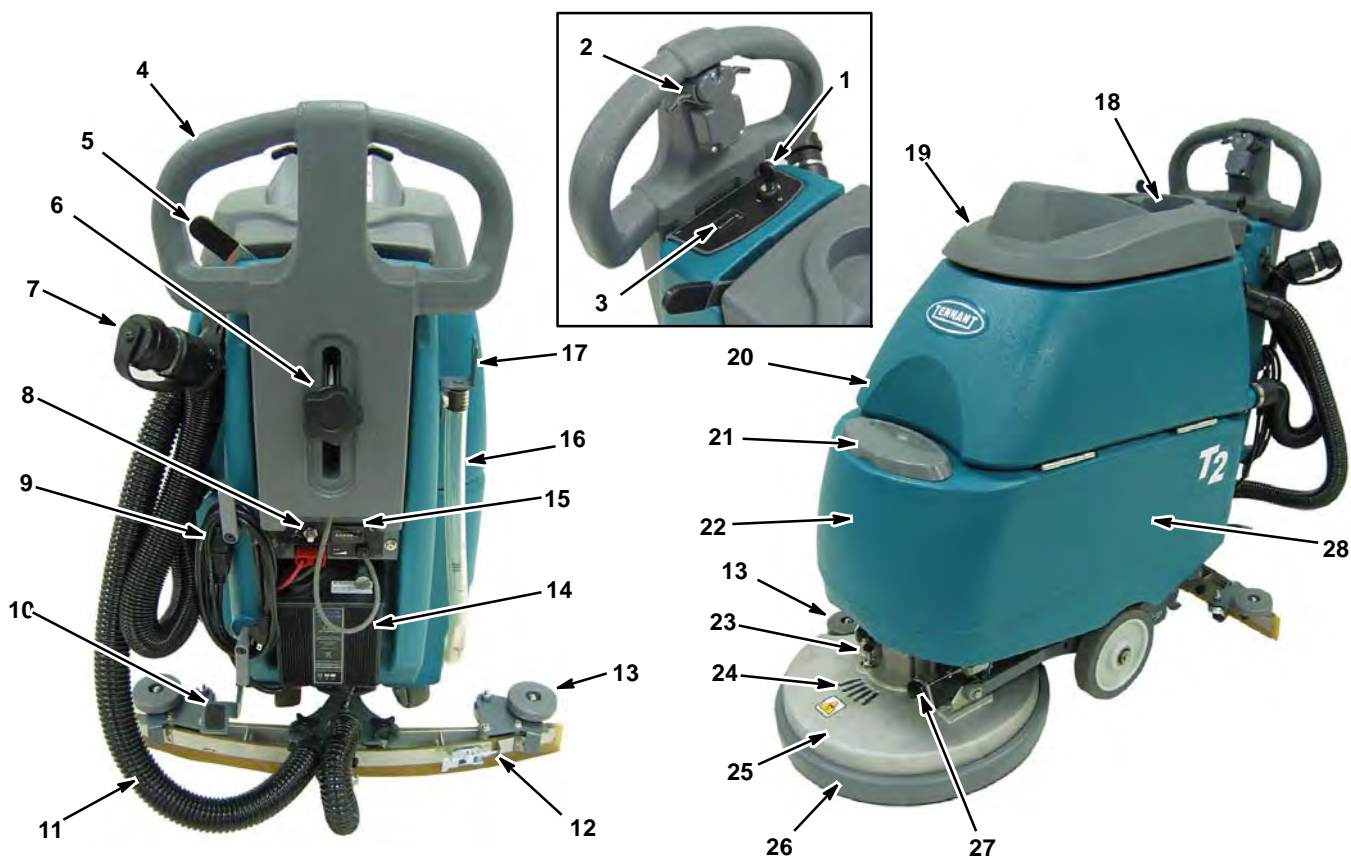

1. Main Power Key Switch
2. Start Triggers
3. Battery Discharge Indicator
4. Adjustable Control Handle
5. Squeegee Lift Lever
6. Control Console Height Adjustment Knob
7. Recovery Tank Drain Hose
8. Brush Motor Circuit Breaker Button
9. On- board Battery Charger Power Cord
10. Scrub Head Lift Pedal
11. Squeegee Vacuum Hose
12. Squeegee Assembly
13. Wall Roller
14. On- board Battery Charger (optional)

15. Hour Meter
16. Solution Tank Fill Gauge/Drain Hose
17. Squeegee Storage Bracket
18. Cup Holder
19. Recovery Tank Cover
20. Recovery Tank
21. Solution Tank Fill- Port
22. Solution Tank
23. Pad Driver/Brush Lock Release Button
24. Pad Driver Window
25. Scrub Head
26. Scrub Head Skirt
27. Solution Flow Control Knob
28. Battery Compartment

MACHINE OPERATION SYMBOLS

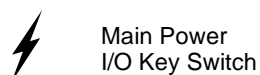

Main Power
I/O Key Switch

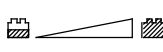

Battery Discharge
Indicator



2% (1°) Maximum
Grade Level



Solution Flow
Control



Brush Motor
Circuit Breaker



Parking Brake
(option)

MACHINE INSTALLATION

UNCRATING MACHINE

1. Carefully check the shipping crate for signs of damage. Report damages at once to carrier.
2. Check the contents list. Contact distributor for missing items.

Contents:

- 2- 12 V Batteries (Optional)
- 2- Foam Battery Spacers
- Battery Tray
- Battery Cable
- Squeegee Assembly

3. Roll machine off pallet using the attached ramp.

ATTENTION: Do not roll machine off pallet unless ramp is used, machine damage may occur.

INSTALLING BATTERIES

⚠ WARNING: Fire Or Explosion Hazard. Batteries Emit Hydrogen Gas. Keep Sparks And Open Flame Away. Keep Battery Hood Open When Charging.

FOR SAFETY: When servicing machine, wear protective gloves and eye protection when handling batteries and battery cables. Avoid contact with battery acid.

Battery Specifications:

Two 12 volt, 70Ah/5h Gel (994200), 72Ah/5h lead acid (1041458), 85Ah/5h lead acid (1041454) deep cycle batteries.

1. Park the machine on a level surface and remove the key.
2. Carefully install the batteries into the battery compartment as shown (Figure 1).
3. Connect the battery cables as shown (Figure 1).

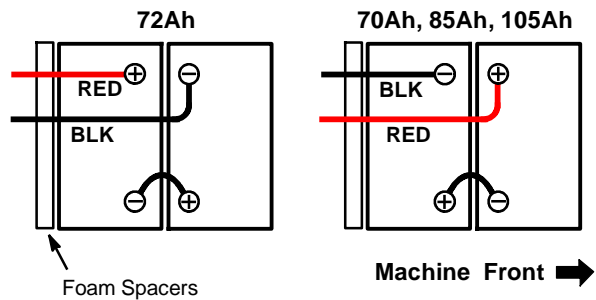

FIG. 1

IMPORTANT: Before charging batteries, make sure the on-board battery charger is properly set for your battery type (See USING THE ON-BOARD CHARGER).

HOW THE MACHINE WORKS

Water and detergent from the solution tank flow to the floor through a manually controlled solution valve. The brush uses the detergent and water solution to scrub the floor clean. As the machine moves forward, the squeegee wipes the dirty solution from the floor into the recovery tank.

BRUSH AND PAD INFORMATION

For best cleaning results use the appropriate brush type for your cleaning application. Refer to the Parts manual for part number information.

Polypropylene Bristle Scrub Brush (Black) - Part No. 1019062

This general purpose polypropylene bristle scrub brush is used for scrubbing lightly compacted soilage. This brush works well for maintaining concrete, wood and grouted tile floors.

Soft Nylon Bristle Scrub Brush (White) - Part No. 1019063

Recommended for cleaning coated floors without removing finish. Cleans without scuffing.

Super Abrasive Bristle Scrub Brush (Gray) - Part No. 1019053

Nylon fiber impregnated with abrasive grit to remove stains and soilage. Strong action on any surface. Performs well on buildup, grease, or tire marks.

Polishing Pad (White) - Part No. 994530

Used to maintain highly polished or burnished floors.

Buffing Pad (Red) - Part No. 994531

Used for light duty scrubbing without removing floor finish.

Scrubbing Pad (Blue) - Part No. 994532

Used for medium to heavy-duty scrubbing. Removes dirt, spills, and scuffs and leaves surface clean ready for recoating.

Stripping Pad (Brown) - Part No. 994533

Used for stripping of floor finish to prepare the floor for recoating.

Heavy Duty Stripping Pad (Black) - Used for aggressive stripping of heavy finishes/sealers, or very heavy duty scrubbing.

MACHINE SETUP

ATTACHING SQUEEGEE ASSEMBLY

1. Park machine on a level surface and remove key.
2. Raise the squeegee mount bracket by moving the squeegee lift lever to the right (Figure 2).



FIG. 2

3. Mount the squeegee assembly to the squeegee pivot bracket as shown (Figure 3). Make sure the knobs are completely seated into the slots before securing knobs.



FIG. 3

4. Connect the vacuum hose to the squeegee assembly. Loop the hose as shown using the hose clip provided (Figure 4).



FIG. 4

5. Check the squeegee blades for proper deflection. The blades should deflect as shown (Figure 5).

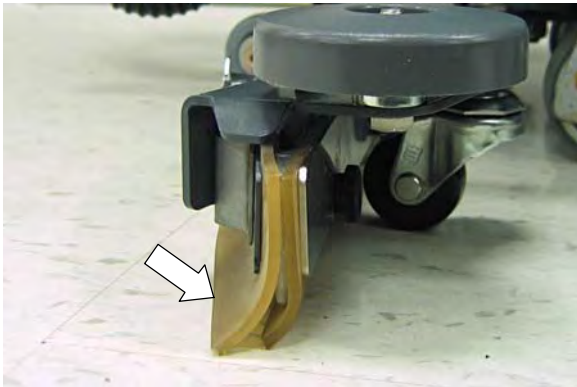

FIG. 5

6. To adjust the blade deflection, place the squeegee assembly on a level surface and adjust the casters as shown (Figure 6).

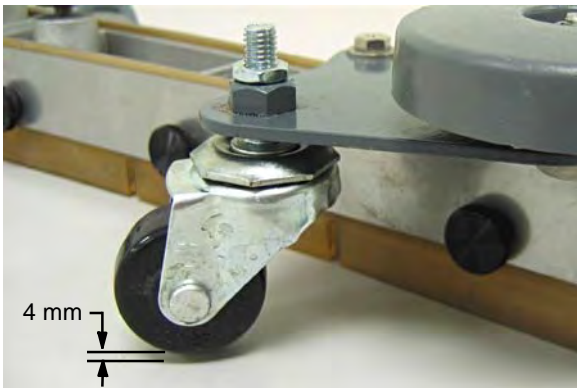

FIG. 6

7. When transporting or storing machine, remove the squeegee assembly and hang it on the storage bracket (Figure 7).

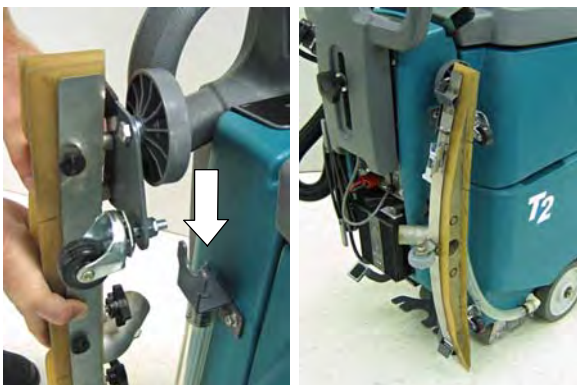

FIG. 7

INSTALLING BRUSHES/PADS

FOR SAFETY: Before installing brushes or pad drivers, stop machine on level surface, remove key and set parking brake if equipped.

1. Park the machine on a level surface and remove key.
2. Step down on the scrub head lift pedal to raise the scrub head off the floor (Figure 8).



FIG. 8

3. Attach the pad to the pad driver and secure pad with centerlock (Figure 9).



FIG. 9

4. Turn the brush motor hub until the slot with the spring clip is visible through the scrub head window (Figure 10).

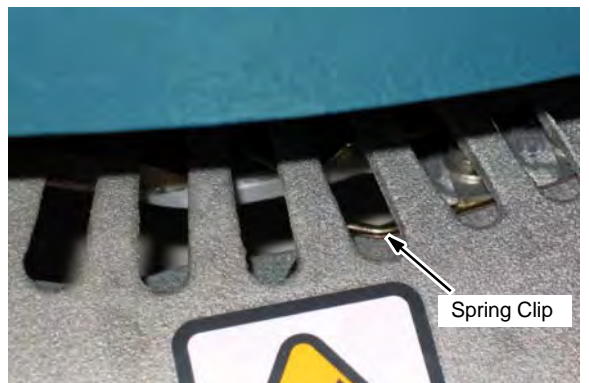

FIG. 10

- Align the pad driver/brush mounting studs with motor hub slots and give the pad driver/brush a quick counter-clockwise turn to engage spring clip (Figure 11).

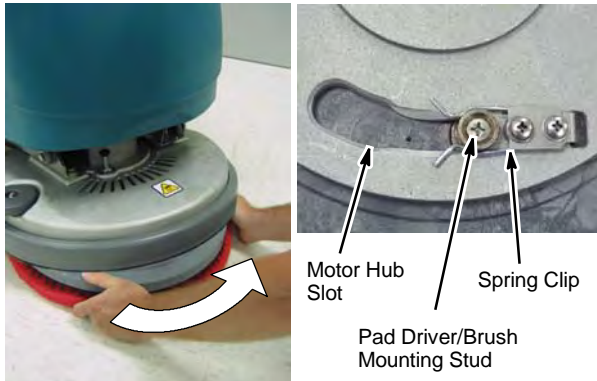

FIG. 11

- To remove the pad driver/brush, press down on the motor hub lock pin and turn the pad driver/brush clockwise (Figure 12).

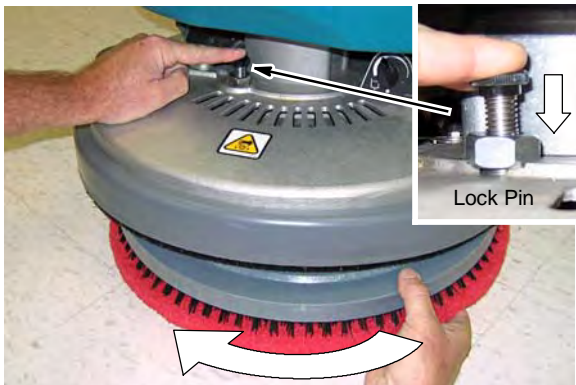

FIG. 12

- When transporting or storing machine, remove the brush and hang it on the storage strap (Figure 13).

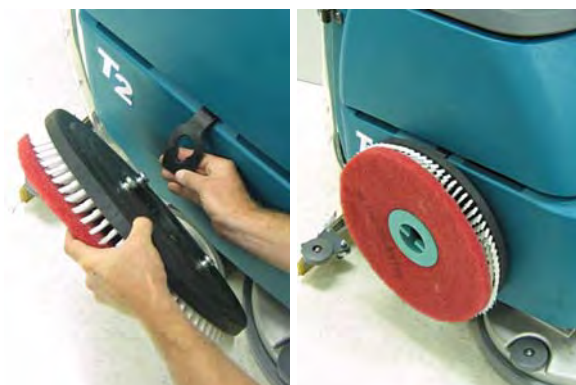

FIG. 13

FILLING SOLUTION TANK

Remove the solution tank cover and fill the tank with 26 liters of water (<60°C temperature). Do not fill beyond the "MAX" level (Figure 14).

NOTE: When filling the solution tank with a bucket, make sure that the bucket is clean. Do not use the same bucket for filling and draining the machine.



FIG. 14

Pour a recommended cleaning detergent into the solution tank according to mixing instructions on the bottle.

ATTENTION: Only use recommended cleaning detergents. Machine damage due to improper detergent usage will void the manufacturer's warranty.

⚠ WARNING: Fire or Explosion Hazard. Never Use Flammable Liquids.

FOR SAFETY: When using machine, follow mixing and handling instructions on chemical containers.

ADJUSTING CONTROL CONSOLE HEIGHT

Loosen the control console height adjustment knob and lift or lower the console to a comfortable operating height. Tighten knob to lock in position (Figure 15).



FIG. 15

MACHINE OPERATION

FOR SAFETY: Do not operate machine, unless operator manual is read and understood.

⚠ WARNING: Fire Or Explosion Hazard. Never Operate Machine In Or Near Flammable Liquids, Vapors Or Combustible Dusts.

PRE- OPERATION CHECKS

- Sweep and dust-mop the floor.
- Check the battery discharge indicator.
- Check pad/brush for wear.
- Check the squeegee blades for wear and proper adjustment.
- Make sure the recovery tank is empty and the float shut-off screen and debris tray are clean.
- Check the scrub head skirt for wear.

OPERATING THE MACHINE

1. Turn the main power key switch to the on (I) position (Figure 16).



FIG. 16

2. Lower the squeegee assembly to the floor by moving the squeegee lift lever to the left (Figure 17). The vacuum motor will automatically turn on.

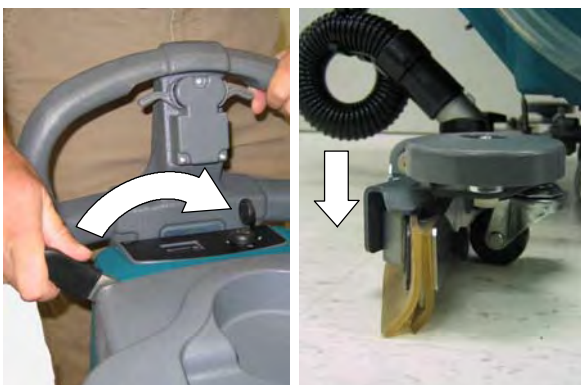

FIG. 17

3. Lower the scrub head to the floor by stepping on the scrub head lift pedal as shown (Figure 18).



FIG. 18

4. Pull the start triggers and slowly push machine forward to begin scrubbing (Figure 19).

NOTE: 45- 60 meters per minute is the recommended scrubbing speed.



FIG. 19

5. Turn the solution flow control knob to a desired flow rate (Figure 20).

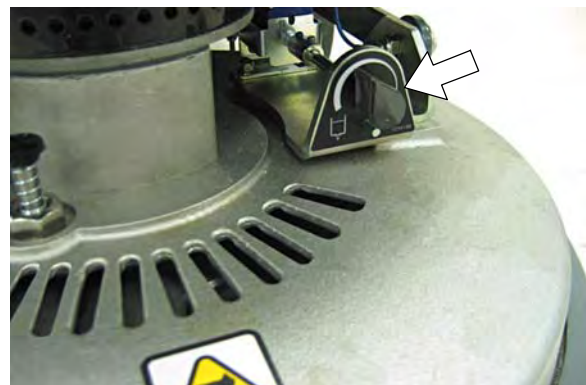

FIG. 20

6. To stop scrubbing, release the triggers, raise the scrub head and the squeegee and turn the key to the off position.

WHILE OPERATING MACHINE

⚠ WARNING: Fire Or Explosion Hazard. Do Not Pick Up Flammable Materials Or Reactive Metals.

1. Overlap each scrubbing path by 5 cm.
2. Keep the machine moving to prevent damage to floor finish.
3. Wipe the squeegee blades with a cloth if blades leave streaks. Pre-sweep the area to prevent streaking.
4. Do not operate the machine on inclines.

FOR SAFETY: When using machine, go slow on inclines and slippery surfaces.

5. Pour a recommended foam control solution into the recovery tank if excessive foam appears.

ATTENTION: Check for excessive foam in the recovery tank. Empty tank if excessive. Foam may not activate the shut-off float which may result in vacuum motor damage.

6. For heavily soiled areas, use the double scrubbing method. First scrub the area with the squeegee up, let solution set for 3-5 minutes, then scrub the area a second time with the squeegee down.
7. When leaving the machine unattended, remove the key and set the parking brake, if equipped.

BATTERY DISCHARGE INDICATOR

The battery discharge indicator displays the charge level of the batteries. When the batteries are fully charged, all indicator lights are lit. As the batteries discharge, the indicator lights will begin to go out from right to left.

To prolong the life of the batteries, do not allow the indicator lights to go beyond the discharge level as described below.

NOTE: ONLY recharge the batteries when the machine is used for a total of 30 minutes or more.

When the discharge level reaches the last yellow light, the light will begin to flash, stop scrubbing and recharge the batteries (Figure 21). If the red light appears, the scrubbing function will shut off automatically. This protects the batteries from total discharge. Recharge the batteries immediately.

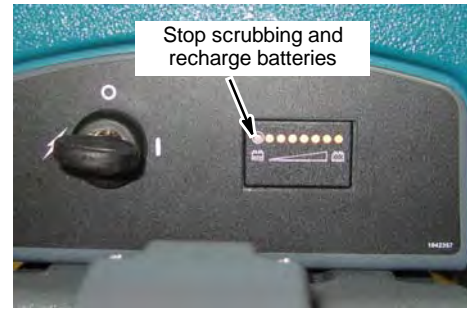

FIG. 21

CIRCUIT BREAKER

The machine is equipped with a resettable circuit breaker to protect the brush motor from damage. The circuit breaker button is located on the control panel (Figure 22). If the circuit breaker should trip, determine the cause, allow the motor to cool, and then manually reset the circuit breaker button.

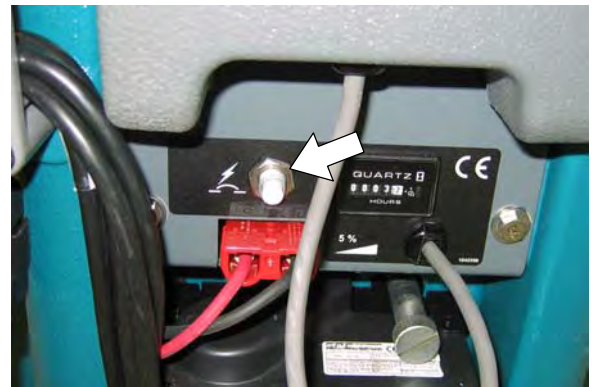

FIG. 22

HOUR METER

The hour meter records the number of total hours the brush motor has been powered on. Use the hour meter to determine when to perform recommended maintenance procedures and to record service history (Figure 23).

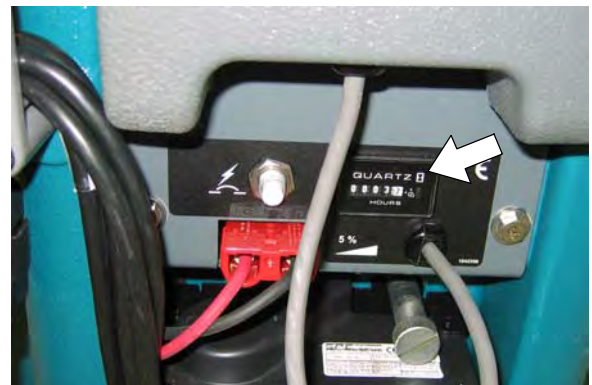

FIG. 23

DRAINING TANKS

The recovery tank should be drained and cleaned out after every use. The solution tank should be cleaned out periodically to remove any water deposit buildup.

FOR SAFETY: Before leaving or servicing machine, stop on level surface, turn off machine and remove key.

DRAINING RECOVERY TANK

1. While holding the drain hose upward, remove the cap and lower hose to drain (Figure 24).



FIG. 24

NOTE: When using a bucket to drain the machine, do not use the same bucket to fill the solution tank.

2. Open the recovery tank cover and rinse out the tank (Figure 25).



FIG. 25

3. Clean the float shut-off screen and debris tray located in the recovery tank (Figure 26).



FIG. 26

DRAINING SOLUTION TANK

To drain any remaining water from the solution tank, pull the solution tank fill gauge hose off the hose fitting (Figure 27).

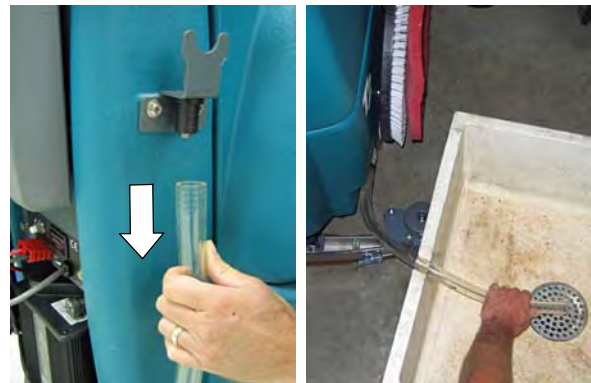

FIG. 27

CHARGING BATTERIES

ATTENTION: To prolong the life of the batteries only recharge the batteries if the machine was used for a total of 30 minutes or more. Do not leave batteries discharged for lengthy periods.

⚠ WARNING: Fire Or Explosion Hazard. Batteries Emit Hydrogen Gas. Keep Sparks And Open Flame Away. Keep Battery Compartment Open When Charging.

FOR SAFETY: When servicing batteries, wear protective gloves and eye protection when handling batteries and battery cables. Avoid contact with battery acid.

BATTERY CHARGER SPECIFICATIONS:

- CHARGER TYPE:
 - FOR SEALED (Gel) BATTERIES
 - FOR WET (Lead acid) BATTERIES
- OUTPUT VOLTAGE - 24 VOLTS
- OUTPUT CURRENT - 9 AMPS
- AUTOMATIC SHUTOFF CIRCUIT
- FOR DEEP CYCLE BATTERY CHARGING

USING THE ON-BOARD BATTERY CHARGER

IMPORTANT: Before charging batteries, make sure the charger profile is properly set for your battery type (ex. lead- acid, gel, etc.). Failure to properly set charger may result in battery damage.

To determine your battery type, see battery label. If not specified, contact your battery supplier.

To verify the setting of the charger profile:

During charger start-up, if the red light flashes twice, the charger is set for wet/lead acid batteries. If the green light flashes twice, the charger is set for a Gel batteries (Figure 28).

NOTE: Refer to the Charger Profile Switch Configuration Table for other battery type settings (Figure 30).

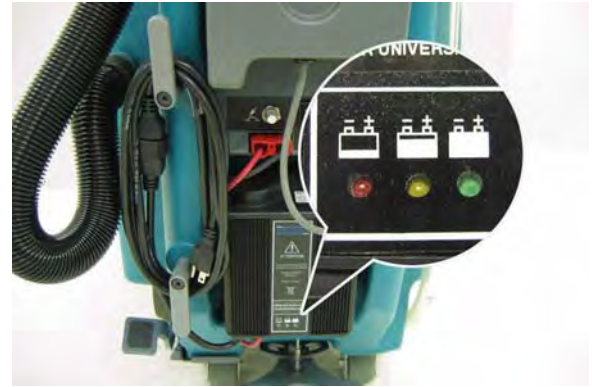

FIG. 28

To change the charger profile:

1. Remove charger from machine (Fig. 29).
2. Remove the plug from the bottom of the charger to access the profile switches (Fig. 29).



FIG. 29

2. Set the profile switches according to the switch configuration table (Fig. 30). The charger cord must be unplugged when resetting.

Charger Profile Switch Configuration Table

Battery	Switch	1	2
Wet (lead acid)		ON	OFF
LM Wet (low maintenance)		ON	ON
Gel		OFF	ON
Exide Gel		OFF	OFF

FIG. 30

To charge batteries:

1. Transport the machine to a well-ventilated area.
2. Park the machine on a flat, dry surface and turn the key off.
3. If charging wet (lead acid) batteries check the fluid level before charging (See BATTERY MAINTENANCE).

- Prop up the recovery tank for ventilation (Figure 31).

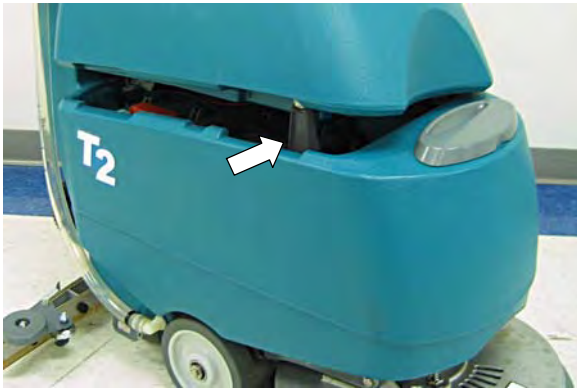

FIG. 31

- Connect the charger's AC power supply cord into a properly grounded receptacle (Figure 32).

NOTE: The machine will not operate when charging.



FIG. 32

- Once the charging cycle begins, the indicator lights will progress from red, yellow to green (Figure 33). When the green indicator light comes on, the charging cycle is done. Unplug the charger cord.

If the charger detects a problem, the charger will display an fault code (See ON- BOARD BATTERY CHARGER FAULT CODES).

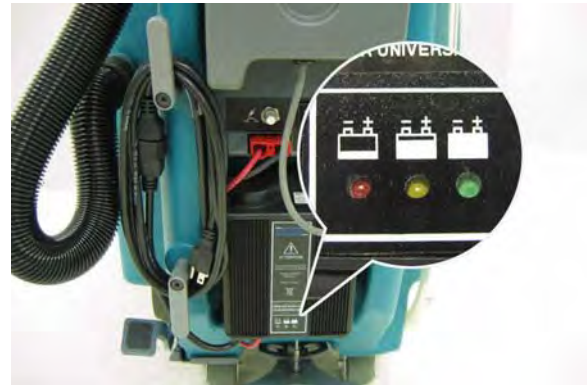

FIG. 33

ON- BOARD BATTERY CHARGER FAULT CODES

FAULT CODE	FAULT	SOLUTION
Yellow Light Flashing	Loose charger cable connection	Check charger cable connection
	Loose or damaged battery cable	Check battery cable connections
	Unsuitable battery	Replace with proper battery
	Output short circuit - damaged output cable	Contact Service Center
	Internal short circuit - blown output fuse	Replace battery charger
Red Light Flashing	Safety timer exceeded maximum charging time	Repeat charging cycle. If error repeats, replace batteries

MACHINE MAINTENANCE

To keep the machine in good working condition, follow the machine maintenance procedures.

⚠ WARNING: Electrical Hazard. Disconnect Battery Cables Before Servicing Machine.

DAILY MAINTENANCE

1. Drain and rinse out the recovery tank (Figure 34).



FIG. 34

2. Remove the debris tray and empty (Figure 35)



FIG. 35

3. Remove and clean the float shut-off screen located in the recovery tank (Figure 36).



FIG. 36

4. Drain the solution tank (Figure 37).

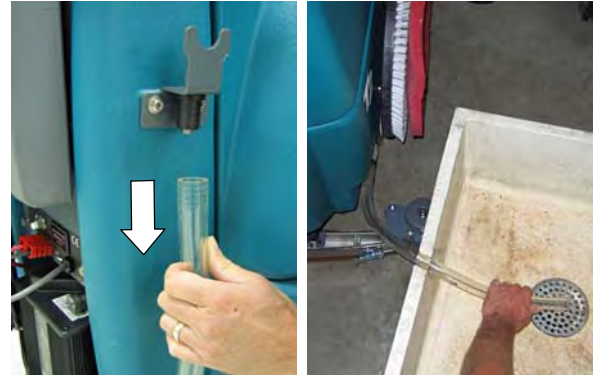

FIG. 37

5. Remove the pad/brush and clean. Rotate pad or replace when worn (Figure 38).

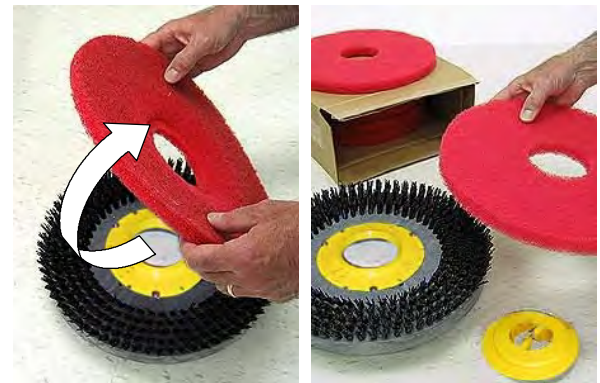

FIG. 38

6. Wipe the squeegee blades clean (Figure 39). When machine is not in use, raise squeegee assembly off floor or hang on storage bracket.

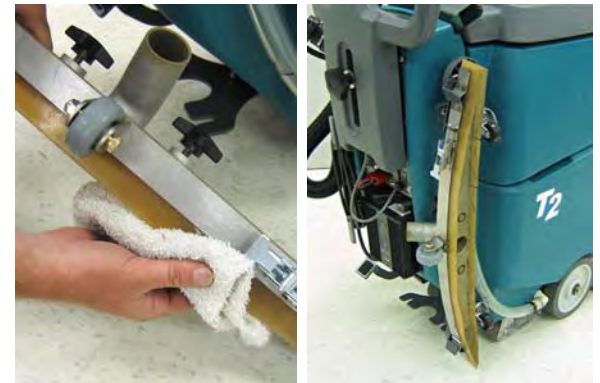

FIG. 39

7. Check the condition of the squeegee blade wiping edge (Figure 40). Rotate blade if worn. (See SQUEEGEE BLADE REPLACEMENT)



FIG. 40

8. Clean the machine with an all purpose cleaner and damp cloth (Figure 41).

FOR SAFETY: When cleaning machine, do not power spray or hose off machine. Electrical malfunction may occur.



FIG. 41

9. Inspect the condition of the scrub head skirt, replace if worn or damaged (Figure 42).



FIG. 42

10. Recharge the batteries after a total of 30 minutes of use or more (Figure 43). (See CHARGING BATTERIES).



FIG. 43

MONTHLY MAINTENANCE

1. Remove the solution tank filter from underneath the machine and rinse out the screen (Figure 44). Make sure the solution tank is empty before removing filter.



FIG. 44

2. Lead Acid Batteries: Clean the battery tops to prevent corrosion (See BATTERY MAINTENANCE).
3. Check for loose battery cable connections.
4. Inspect and clean the recovery tank cover seal (Figure 45). Replace if damaged.



FIG. 45

5. Lubricate all pivot points and rollers with silicone spray then coat with a water resistant grease to maintain smooth operation.
6. Check the machine for loose nuts and bolts.
7. Check the machine for leaks.

MOTOR MAINTENANCE

Contact an Authorized Tennant Service Center for carbon brush replacement.

Carbon Brush Replacement	Hours
Vacuum Motor	750
Brush Motor	750

⚠ WARNING: Electrical Hazard. Disconnect Battery Cables Before Servicing Machine.

SQUEEGEE BLADE REPLACEMENT

Each squeegee blade has four wiping edges. When the blades become worn, simply rotate the blades end-for-end or top-to-bottom for a new wiping edge. Replace blade if all four edges are worn.

1. Remove the squeegee assembly from the machine.
2. Loosen the band clamp and remove the band from the squeegee assembly (Figure 46).

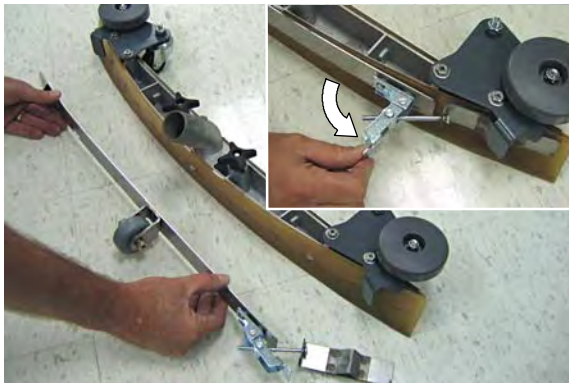

FIG. 46

3. Remove and rotate the rear blade to a new wiping edge. (Figure 47).

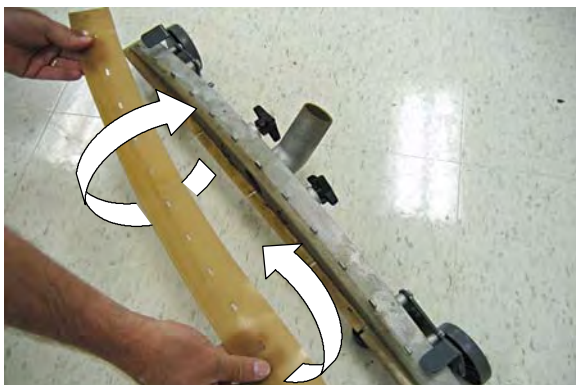

FIG. 47

4. Remove the thumb screws from the front blade and rotate blade end-for-end (Figure 48).

NOTE: Use the 5-slot edge use on VCT flooring (vinyl composite tile) and the 3-slot edge on grouted tile floors.



FIG. 48

BATTERY MAINTENANCE (Lead Acid Batteries)

1. Check battery fluid level frequently to prevent battery damage. The fluid should be at the level shown (Figure 49). Add distilled water if low. **DO NOT OVERFILL**, the fluid may expand and overflow when charging.



CORRECT BATTERY FLUID LEVEL:

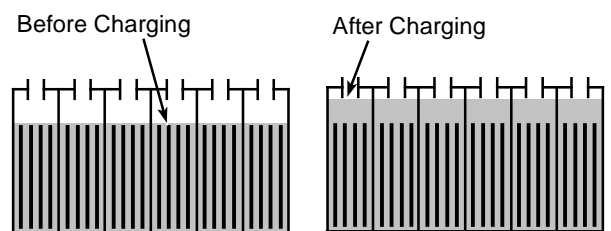

FIG. 49

⚠ WARNING: Fire Or Explosion Hazard. Batteries Emit Hydrogen Gas. Keep Sparks And Open Flame Away. Keep Battery Compartment Open When Charging.

2. Clean the batteries to prevent battery corrosion. Use a scrub brush with a mixture of baking soda and water (Figure 50).

FOR SAFETY: When cleaning batteries, wear protective gloves and eye protection. Avoid contact with battery acid.



FIG. 50

TRANSPORTING MACHINE

When transporting the machine by use of trailer or truck, be certain to follow the tie-down procedure below:

1. Raise the scrub head and hang squeegee squeegee on storage bracket.
2. Load the machine using a recommended loading ramp.
3. Position the front of machine up against the front of the trailer or truck and lower the scrub head.
4. Place a block behind each wheel to prevent the machine from rolling.
5. Secure machine with tie-down straps. Machine is equipped with two tie-down brackets (Figure 51).

FOR SAFETY: When transporting machine, use a recommended ramp when loading/unloading into/off truck or trailer. Use tie-down straps to secure machine to truck or trailer.

STORING MACHINE

1. Charge the batteries before storing. Never store the machine with discharged batteries.
2. Drain and rinse the tanks thoroughly.
3. Store the machine in a dry area with the squeegee and scrub head in the up position.
4. Open the recovery tank cover to promote air circulation.

ATTENTION: Do not expose machine to rain, store indoors.

5. If storing machine in freezing temperatures, follow the FREEZE PROTECTION instructions below.

FREEZE PROTECTION

1. Drain the solution tank and recovery tank of all water.
2. Empty the solution tank filter located under the machine (Figure 51).



FIG. 51

3. Pour 1 gallon (4 liters) of recreational vehicle (RV) antifreeze into the solution tank at full strength. Do not dilute.
4. Turn the machine power on and operate the solution flow system. Turn the machine off when the red RV antifreeze is visible.

TROUBLESHOOTING

PROBLEM	CAUSE	SOLUTION
Machine will not operate	Discharged batteries	Charge batteries
	Faulty battery(s)	Replace battery(s)
	Loose battery cable	Tighten loose cable
	Faulty key switch	Contact Service Center
On-board battery charger will not operate	Plug not connected to power supply	Check plug connection
	Faulty power supply cord	Replace cord
	Fault detected.	See ON-BOARD BATTERY CHARGER FAULT CODES
Brush motor will not operate	Scrub head is raised off floor	Lower scrub head
	Tripped brush motor circuit breaker	Reset brush circuit breaker button
	Faulty scrub head (up/down) switch	Contact Service Center
	Faulty Control handle triggers	Contact Service Center
	Faulty brush motor or wiring	Contact Service Center
	Worn carbon brushes	Contact Service Center
Vacuum motor will not operate	Squeegee is raised off floor	Lower squeegee
	Vacuum motor fuse blown	Replace 25 Amp fuse
	Faulty vacuum motor or wiring	Contact Service Center
	Worn carbon brushes	Contact Service Center
Little or no solution flow	Clogged solution tank filter or solution hose	Clean solution tank filter or flush out solution hose
	Clogged solution valve	Remove valve and clean
	Solution flow control knob set too low	Adjust solution control flow knob
	Loose screw on control knob	Calibrate knob and retighten screw
Poor water pickup	Recovery tank is full	Drain recovery tank
	Loose drain hose cap	Tighten cap
	Clogged float shut-off screen located in recovery tank	Clean screen
	Clogged squeegee assembly	Clean squeegee assembly
	Worn squeegee blades	Replace or rotate squeegee blades
	Incorrect Squeegee blade deflection	Adjust Squeegee blade height
	Loose vacuum hose connections	Secure hose connections
	Clogged vacuum hose	Remove clogged debris
	Damaged vacuum hose	Replace vacuum hose
	Recovery tank cover not in place	Properly position cover
	Damaged recovery tank cover seal	Replace seal
	Faulty vacuum motor	Contact Service Center
	Low battery charge	Recharge batteries.
Short run time	Batteries not fully charged	Fully recharge batteries
	Defective batteries	Replace battery
	Service batteries	See BATTERY MAINTENANCE
	Faulty battery charger	Repair or replace battery charger

SPECIFICATIONS

T2 MODEL	
LENGTH	1120 mm
WIDTH	478 mm
HEIGHT	930 mm
WEIGHT	80 Kg / 136 Kg with batteries
MINIMUM AISLE TURN	1219 mm
RECOVERY TANK CAPACITY	36 L
SOLUTION TANK CAPACITY	26 L
PRODUCTIVITY RATE (Estimated Actual)	672 m ² per hour
CLEANING PATH WIDTH	430 mm
PAD PRESSURE	23 Kg
SQUEEGEE WIDTH	696 mm
BRUSH MOTOR	0.75 Kw, 230 rpm, 24 V, 37 A
VACUUM MOTOR	0.30 kW, 2- stage 5.7, 24 V, 13 A
WATER LIFT	100 Mbar
BATTERY CAPACITY	(2) 12 V, 85 Ah / 5 hr rate, 72 Ah / 5 hr rate, 70 Ah / 5 hr rate
RUN TIME PER CHARGE	85Ah Batteries - Up to 2 hours
	72Ah Batteries - Up to 1.75 hours
	70Ah Batteries - Up to 1.75 hours
ON- BOARD BATTERY CHARGER	100- 240 VAC, 5.3 A, 50/60 Hz, 24 VDC, 9 A output
VOLTAGE DC	24 VDC
TOTAL POWER CONSUMPTION	25 Amp nominal
PROTECTION GRADE	IPX3
DECIBEL RATING AT OPERATOR'S EAR, INDOORS*	68 dB(A)
VIBRATIONS AT HAND CONTROLS	<2.5m/s ²
MAXIMUM GRADE LEVEL	2%

* Measured A- weighted emission sound pressure level, per ISO 11201, in accordance with ISO 4871. Uncertainty value is 2 decibels.

MACHINE DIMENSIONS

